

INSTALLATION INSTRUCTIONS

4" OVAL SIDE BAR
 2011 JEEP GRAND CHEROKEE
 PART NUMBER S221008/S221008-2

PARTS LIST:

| | | | |
|---|---------------------------------------|----|--|
| 1 | Passenger Side Bar | 8 | 10-1.50mm x 30mm Hex Head Bolts |
| 1 | Driver Side Bar | 9 | 10mm ID x 20mm OD x 1.5mm Flat Washers |
| 1 | Passenger Side Front Mounting Bracket | 9 | 10mm Lock Washers |
| 1 | Driver Side Front Mounting Bracket | 8 | 6-1.25mm x 20mm Hex Head Bolts |
| 1 | Passenger Side Rear Mounting Bracket | 16 | 8mm ID x 23.5mm OD x 2mm Flat Washers |
| 1 | Driver Side Rear Mounting Bracket | 8 | 6mm Lock Washers |
| 1 | 10mm x 25mm bolt tab | 8 | 6mm Nuts |
| 1 | 10mm Nut | | |

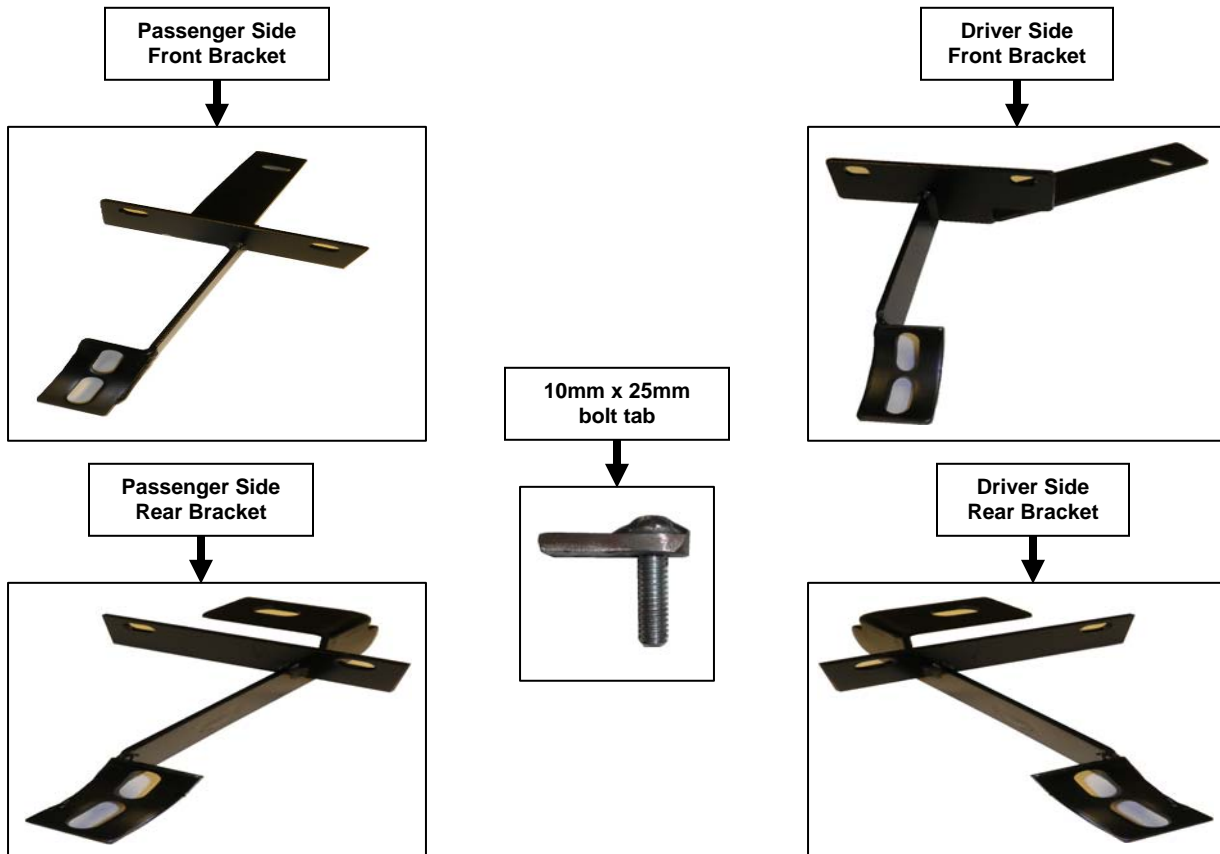
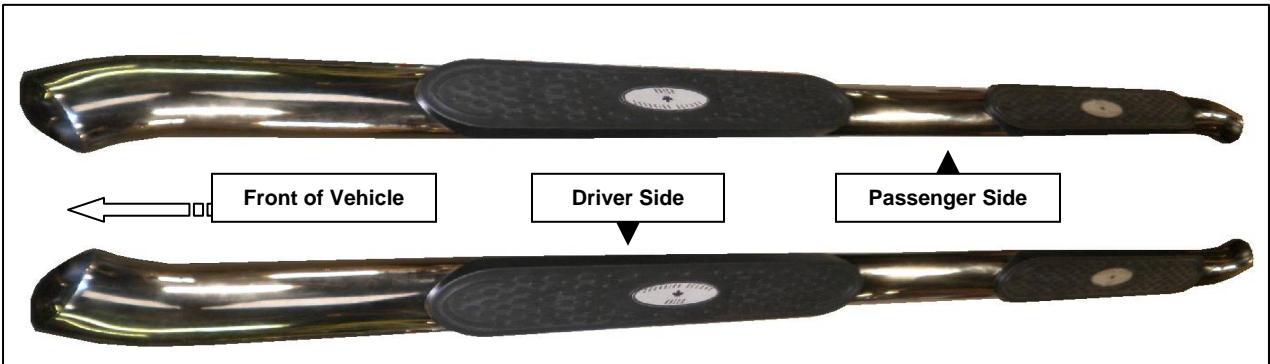

PROCEDURE:

1. REMOVE CONTENTS FROM BOX. VERIFY ALL PARTS ARE PRESENT. READ INSTRUCTIONS CAREFULLY BEFORE STARTING INSTALLATION.
2. Starting with the Driver/left side front mount bracket, locate and remove the skid shield bolt as seen in **(Fig 1)**. With bolt removed install mount bracket as seen in **(Fig 2)** to the bottom of the rocker panel drip rail with the (2) 6mm hex bolts, (4) 8mm flat washers, (2) 6mm lock washers and (2) 6mm Nuts re-attach skid shield bolt. Snug but do not tighten at this time.
3. Locate and remove the rear skid shield bolt as seen in **(Fig 3)**. With bolt removed install the Driver/left side bracket as seen in **(Fig 4)** to the bottom of the rocker panel drip rail with the (2) 6mm hex bolts, (4) 8mm flat washers, (2) 6mm lock washers and (2) 6mm Nuts re-attach skid shield bolt. Snug but do not tighten at this time.
4. Position Driver/left Side Bar onto Mounting Brackets. Attach Side Bar to Mounting Brackets using the included (4) 10mm x 30mm Hex Head Bolts, (4) 10mm Lock Washers, and (4) 10mm Flat Washers. Level and adjust Side Bar, then tighten all hardware at this time.
5. For the Passenger/right side front mount bracket, locate and install the bolt tab into the bottom of the frame rail as seen in **(Fig 5)**. With bolt tab installed mount the bracket as seen in **(Fig 6)** to the bottom of the rocker panel drip rail with the (2) 6mm hex bolts, (4) 8mm flat washers, (2) 6mm lock washers and (2) 6mm Nuts Attach the (1) 10mm flat washer (1) 10mm lock washer and (1) 10mm Nut to the bolt tab. Snug but do not tighten at this time.
6. Locate and remove the rear skid shield bolt as seen in **(Fig 7)**. With bolt removed install the Passenger/right side bracket as seen in **(Fig 8)** to the bottom of the rocker panel drip rail with the (2) 6mm hex bolts, (4) 8mm flat washers, (2) 6mm lock washers and (2) 6mm Nuts re-attach skid shield bolt. Snug but do not tighten at this time.
7. Position Passenger Side Bar onto Mounting Brackets. Attach Side Bar to Mounting Brackets using the included (4) 10mm x 30mm Hex Head Bolts, (4) 10mm Lock Washers, and (4) 10mm Flat Washers Level and adjust Side Bar, then tighten all hardware at this time.

8. Do periodic inspections to the installation to make sure that all hardware is secure and tight.

To protect your investment, wax this product after installing. Regular waxing is recommended to add a protective layer over the finish. Do not use any type of polish or wax that may contain abrasives that could damage the finish.

For stainless steel: Aluminum polish may be used to polish small scratches and scuffs on the finish. Mild soap may be used also to clean the Product.

For gloss black finishes: Mild soap may be used to clean the Product.

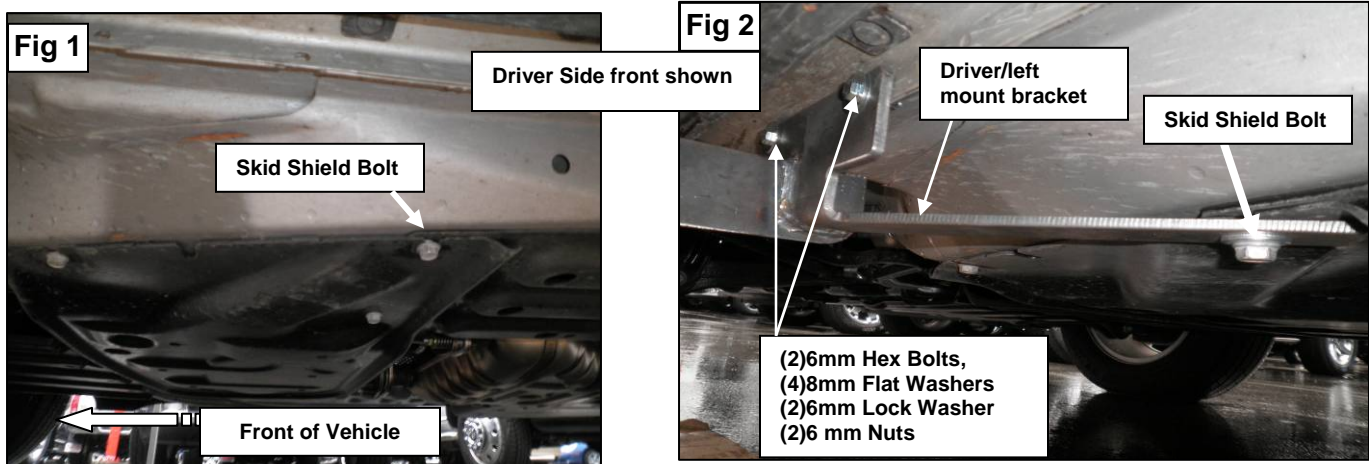

Fig 3

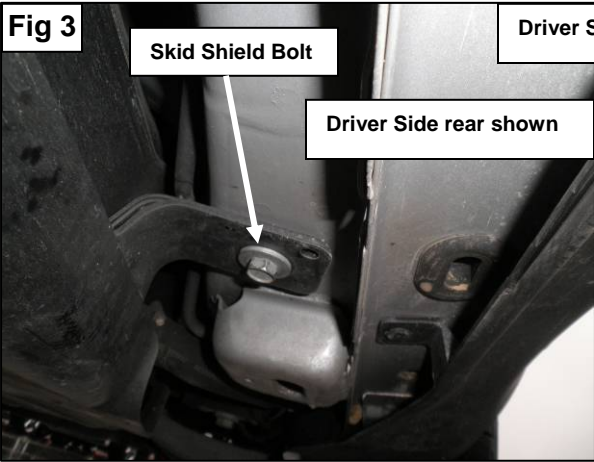
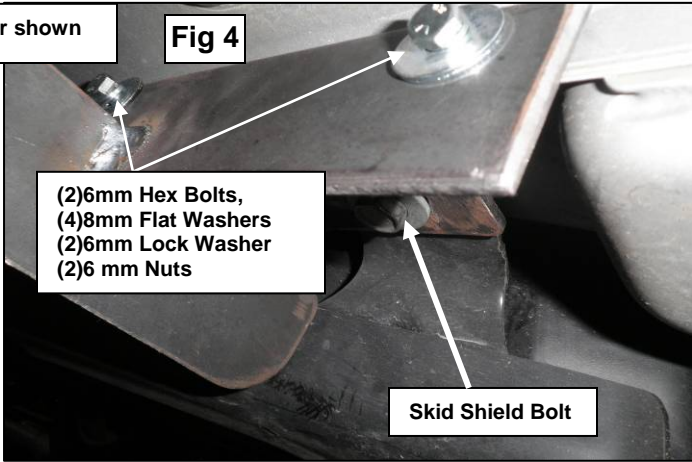

Fig 4



Passenger Side front shown

Fig 5

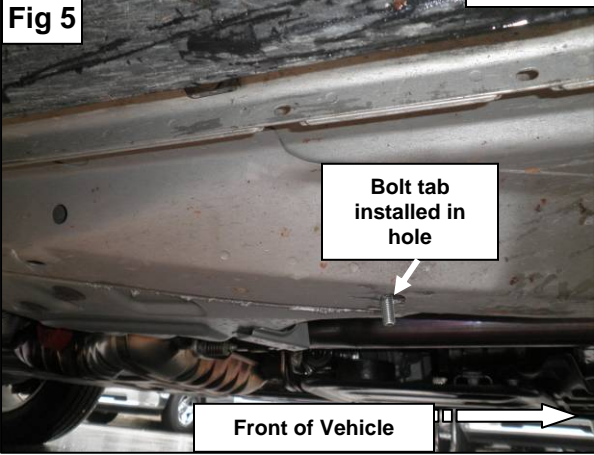

Fig 6

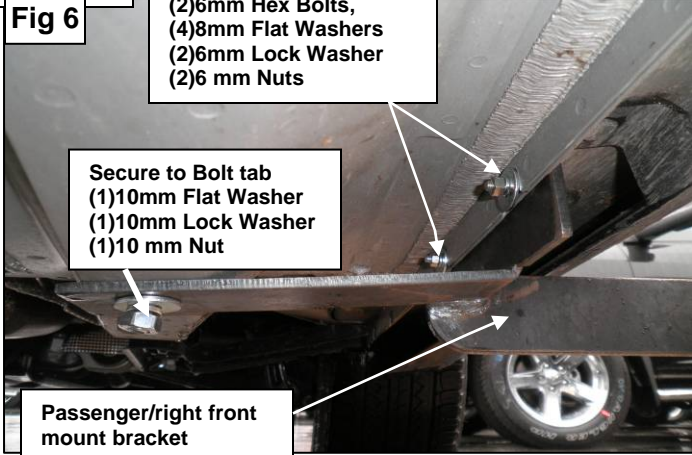

Fig 7

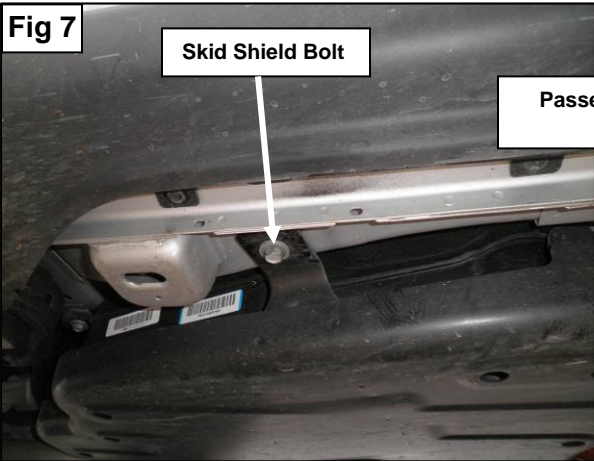

Fig 8

