

INSTALLATION MANUAL

13612

Level of Difficulty

Difficult

Installation difficulty levels are based on time and effort involved and may vary depending on the installer level of expertise, condition of the vehicle and proper tools and equipment.

Weight Carrying Capacity

Gross trailer weight (GTW)	5,000 lbs.
Tongue weight (TW)	750 lbs.

Parts List

Item	Qty	Description
1	1	Trailer hitch

Tools Required

Socket, 10mm deep well	Panel trim removal tool
Socket, 17mm	Rotary tool
Ratchet	Torque wrench
Torx bit socket, T-25	Tape measure
Torx bit socket, T-30	Tape
Socket extension, 6"	--

* For a tools reference guide visit curtmfg.com/trailer-hitch-installation

Product Registration and Warranty

CURT stands behind our products with industry-leading warranties. To get copies of the product warranties, register your purchase or provide feedback, visit: warranty.curtgroup.com/surveys

⚠ WARNING

Never exceed the vehicle manufacturer's recommended towing capacity.

Product Photo



NOTICE

Visit www.curtmfg.com for a full-color copy of this instruction manual, as well as helpful videos, guides and much more!

Before you begin installation, read all instructions thoroughly.

Proper tools will improve the quality of installation and reduce the time required.

This installation requires:

- Temporary removal of rear fascia and trunk panel
- Trimming of rear fascia (Porsche and Audi models without hitch access panel)

Periodic inspection of the trailer hitch should be performed to ensure all mounting hardware remains tight and structural components are secure.

To help prevent damage to the product or vehicle, refer to the specified torque specifications when securing hardware during the installation process.

SAFETY INSTRUCTIONS

Safety glasses should be worn at all times while installing this product.

ASSEMBLY

Parts List

Item	Qty	Description
1	1	Hitch assembly

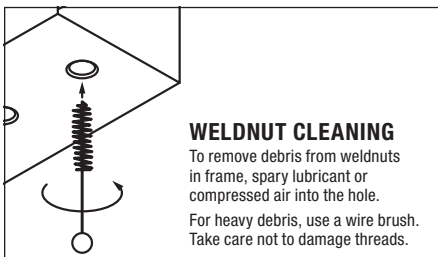
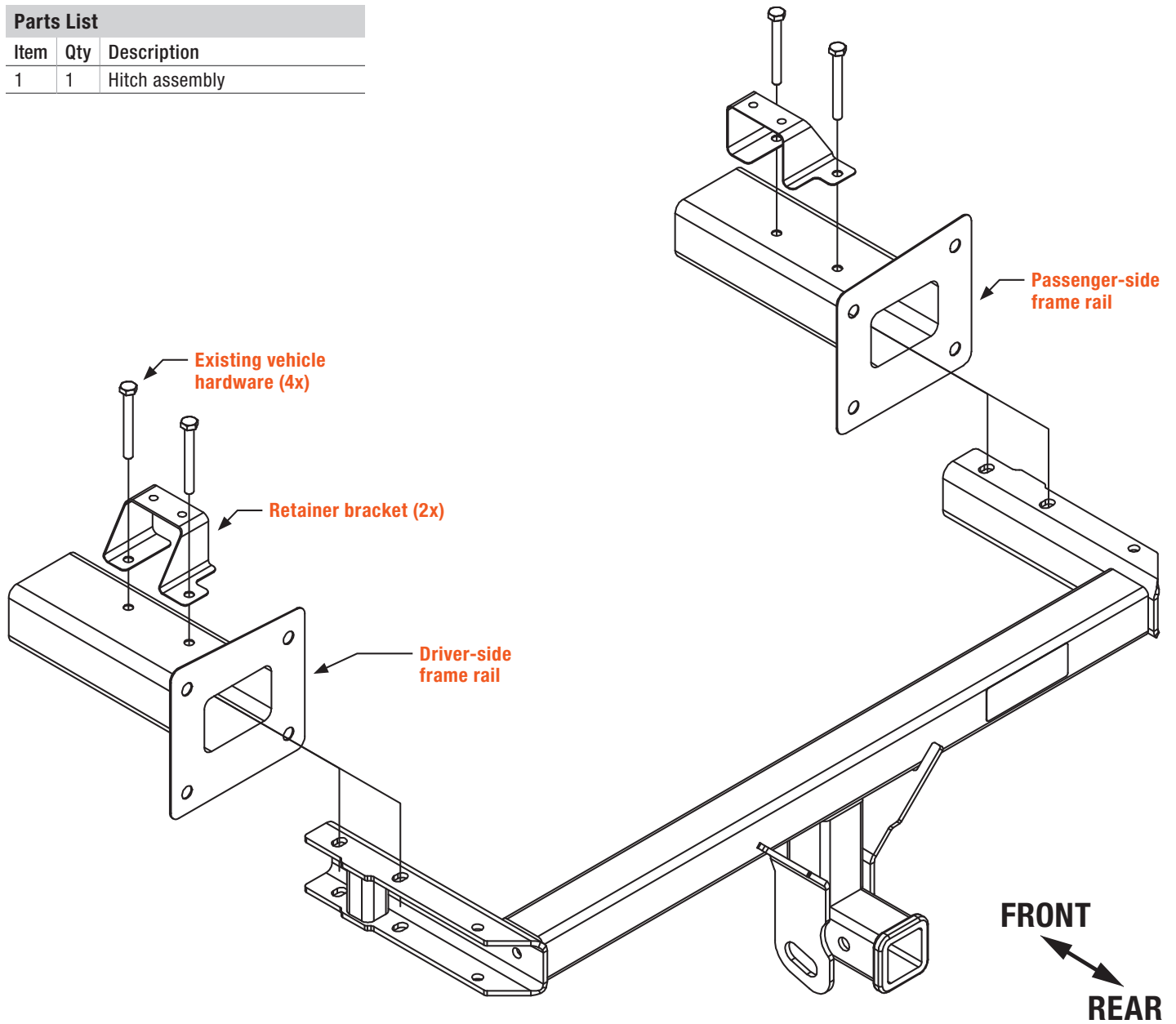

Step 1

Remove the trunk floor panel and storage tray if equipped.

For Audi: Using a trim panel tool, remove the scuff plate. Disconnect the electrical plug attached to the scuff plate and set aside.

For Porsche: Using a 10mm socket, remove the two (2) plastic fasteners retaining the scuff plate. Using a trim panel tool, remove the scuff plate.



Step 2

For Audi: Using a 10mm socket, remove the two (2) M6 nuts located on the recessed studs under the scuff plate area.

For Porsche: Using a T30 socket, remove one (1) bolt and rubber stopper per side retaining the bumper fascia in the trunk opening.

Gently remove the taillight trim panel on both sides using a trim panel removal tool. Using a T25 socket, remove one (1) bolt from the fascia on both sides.



Step 3

Using a T-30 socket, remove the four (4) cargo hold down rings.

Remove the two (2) side rails.

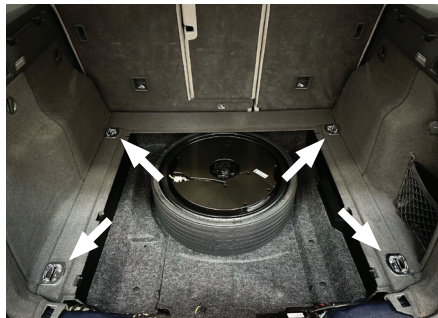

Step 4 (For Porsche, skip to step 6)

For Audi: Remove the driver-side interior panel.

Unstrap and remove the air compressor.

Unscrew the two (2) retainers and remove the styrofoam air compressor bracket.

Using a 10mm socket, remove one (1) M6 nut from the bumper fascia stud located in the interior panel compartment.

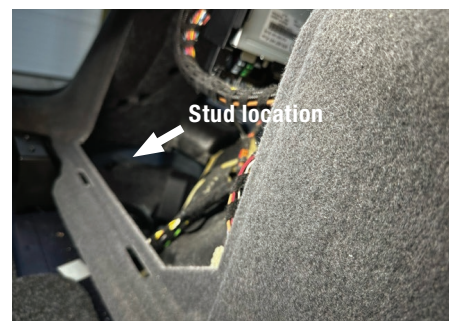

Step 5

For Audi: Remove the passenger side interior panel. Disconnect the power outlet electrical connector on the backside of the panel.

Using a 10mm socket, remove the one (1) M6 nut holding the fuse box in place.

Leaving the electrical connectors in place, lift the fuse box out of the way and set aside.

Using a 10mm socket, remove one (1) M6 nut from the bumper fascia stud located in the interior panel compartment.

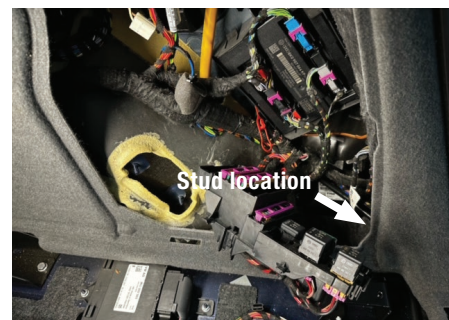

Step 6

Using a T-25 socket, remove four (4) torx screws per side from the driver- and passenger-side wheel well liners.

For Porsche: Gently pull the wheel well liner towards the wheel to access fascia fasteners on both driver and passenger side.

Using a T-25 socket, remove the (4) screws per side from the inside edge and upper corner of the bumper fascia.



Step 7

Using a T-25 socket, remove (2) torx screws fastening the bumper fascia to the underbody.

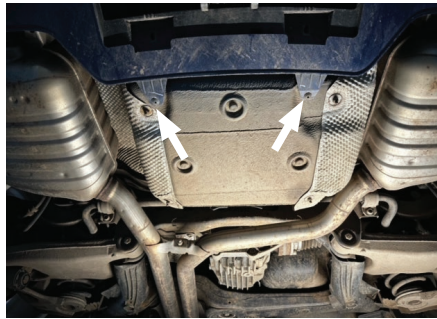

Step 8

Gently remove the bumper fascia starting from the sides and working towards the rear of the vehicle.

Carefully pull the bumper fascia away from the vehicle and disconnect electrical connectors from bumper fascia.

Set bumper fascia aside for later reinstallation.

Note for Porsche Macan:

Disconnect washer hose from fascia.

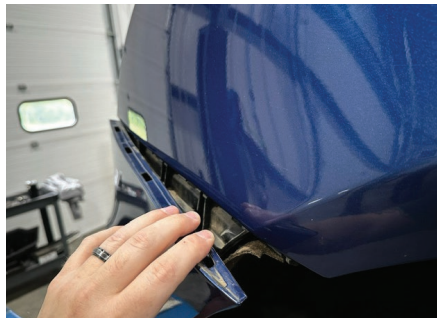

Step 9

Using a 17mm socket, remove (2) M10 bolts per side. Set the retainer brackets aside.

Pull the bumper beam out of the frame rails to remove. Set bumper beam aside and return to owner.

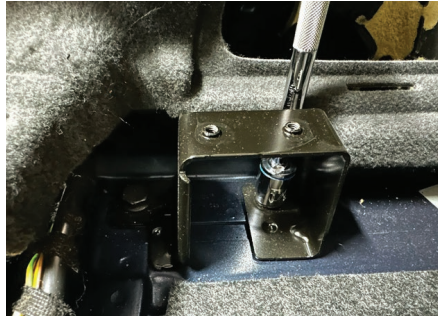

Step 10

Slide the hitch into the frame rails, aligning the hitch mounting slots with the retaining bracket holes on each side.

Place retaining brackets back in position and reinstall the (2) M10 bolts per side.

Torque M10 bolts to 44 ft-lbs.



Step 11

For Audi Q5 with bumper fascia hitch access panel: Using a T25 socket, remove (2) torx screws and remove hitch access panel from bumper fascia. Return access panel to owner.

For Audi Q5 without bumper fascia hitch access panel and Porsche Macan S and Turbo models: Mark and trim the lower fascia panel as shown.

For Porsche Macan GTS models:
Trim the lower fascia panel as necessary.

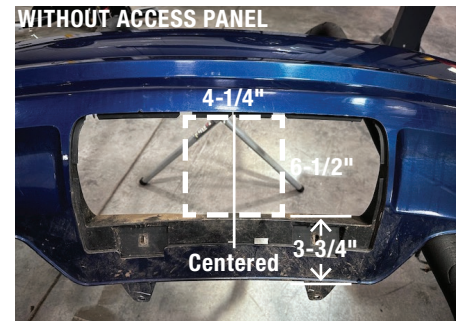
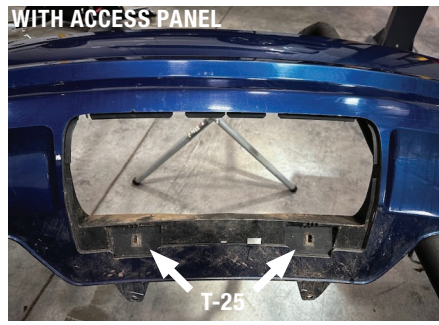

Step 12

Reinstall all components in the reverse order of removal.

Note: Torque M6 fasteners to 7 ft-lbs.

Torque T30 fasteners to 3 ft-lbs.

Torque T25 fasteners to 1.1 ft-lbs.

Final Installed Image



TOWING BASICS & SAFETY INFORMATION

For information on safely towing your trailer, visit curtmfg.com/understanding-towing.