

INSTALLATION MANUAL

13510

Level of Difficulty

Easy

Installation difficulty levels are based on time and effort involved and may vary depending on the installer level of expertise, condition of the vehicle and proper tools and equipment.

Weight Carrying Capacity

Gross trailer weight (GTW)	3,500 lbs.
Tongue weight (TW)	525 lbs.

Parts List

Item	Qty	Description
1	4	Hex bolt, M12
2	4	Conical-toothed washer, 1/2"

Tools Required

Flathead screwdriver	Ratchet
Torque wrench	Cut-off wheel
Phillips screwdriver	Tape
Socket, 19mm	--

* For a tools reference guide visit curtmfg.com/trailer-hitch-installation

⚠ WARNING

Never exceed the vehicle manufacturer's recommended towing capacity.

Product Photo



NOTICE

Visit www.curtmfg.com for a full-color copy of this instruction manual, as well as helpful videos, guides and much more!

Before you begin installation, read all instructions thoroughly.

Proper tools will improve the quality of installation and reduce the time required.

This installation requires:

- Underbody support trimming
- Hitch panel removal

Periodic inspection of the trailer hitch should be performed to ensure all mounting hardware remains tight and structural components are secure.

To help prevent damage to the product or vehicle, refer to the specified torque specifications when securing hardware during the installation process.

SAFETY INSTRUCTIONS

Safety glasses should be worn at all times while installing this product.

Product Registration and Warranty

CURT stands behind our products with industry-leading warranties. To get copies of the product warranties, register your purchase or provide feedback, visit: warranty.curtgroup.com/surveys

ASSEMBLY

Parts List

Item	Qty	Description
1	4	Hex bolt, M12
2	4	Conical-toothed washer, 1/2"

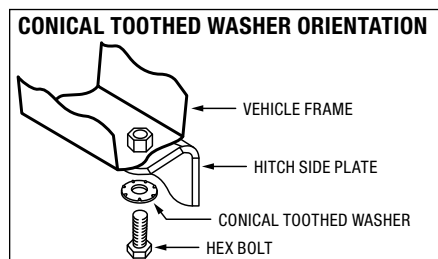
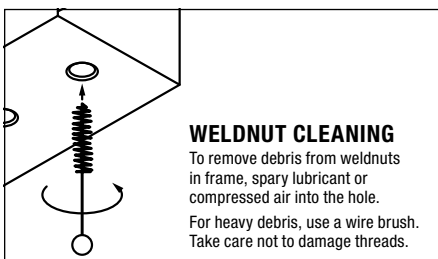
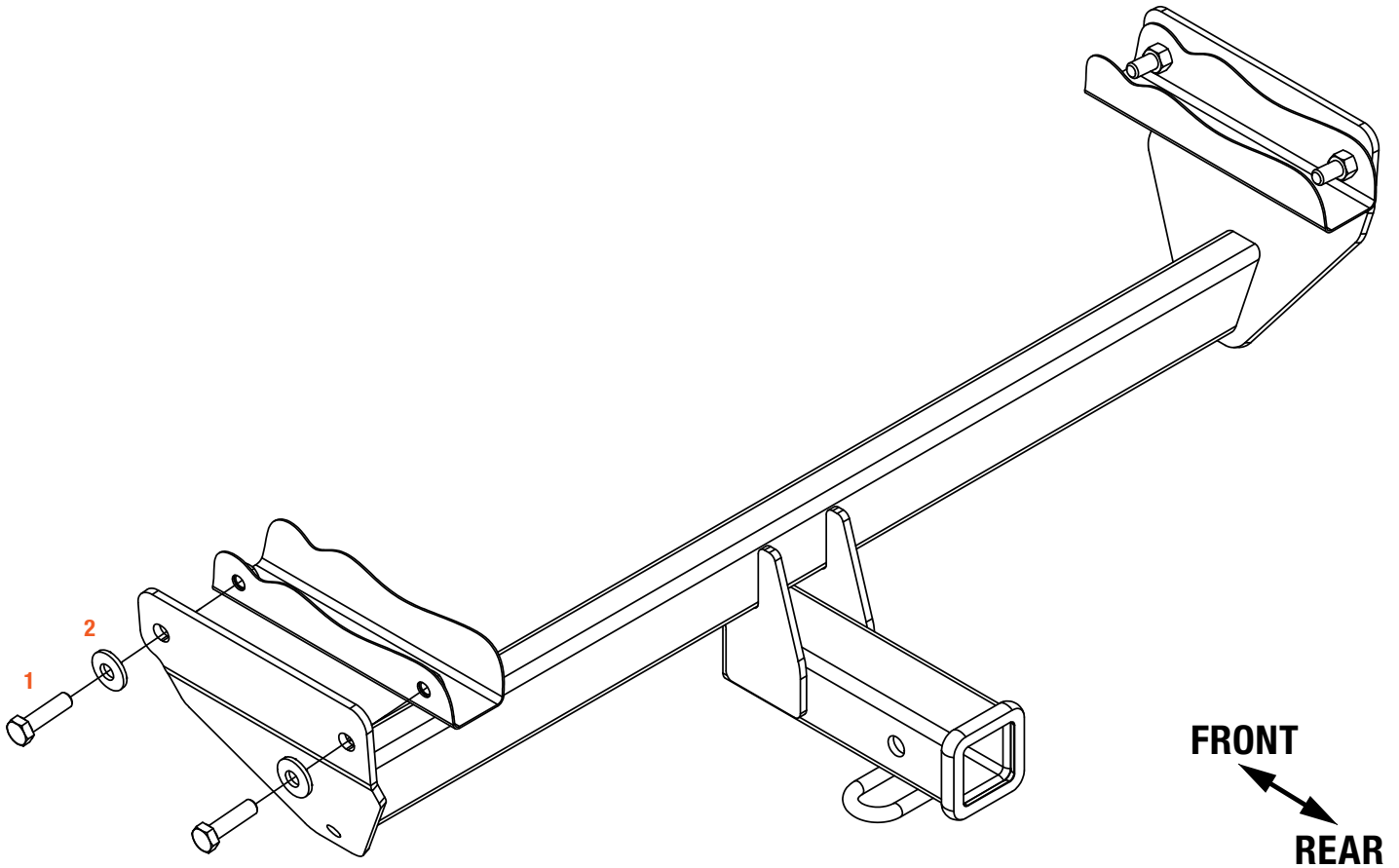

Step 1

Remove the two push fasteners from the center of the bumper fascia.

Remove the hitch panel from the center of the bumper by removing two screws and returning them to the vehicle owner.

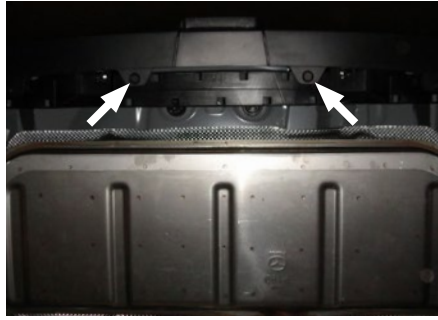

Step 2

Use tape to mark the bumper support in line with the slot for the hitch panel and trim the center of the bumper support.

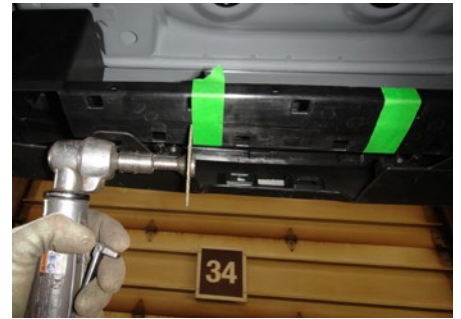

Step 3

Use a flathead screwdriver to remove the tape from the outside of the frame rails covering the weldnuts in the frame.



Step 4

Raise the hitch into position and secure with M12 hex bolts (#1) and serrated conical toothed washers (#2).

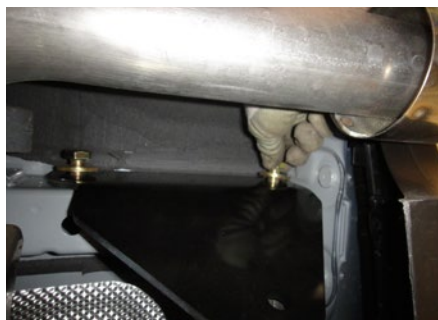

Step 5

Torque all M12 hardware to 86 ft-lbs.

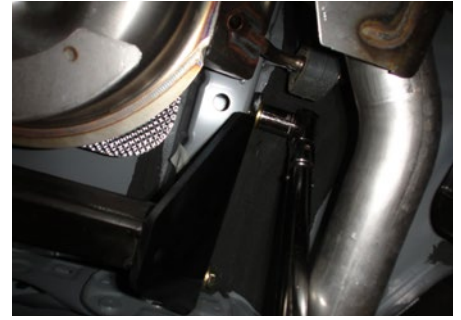

Final Installed Image



TOWING BASICS & SAFETY INFORMATION

For information on safely towing your trailer, visit [curtmfg.com/understanding-towing](https://www.curtmfg.com/understanding-towing).