



BX3833

2012-15 Volkswagen Passat SEL/SE (Includes TDI) Installation Instructions

Attachment Tab Height: 14-1/2"

Attachment Tab Width: 24"

Serial Number

Please read BOTH these Installation Instructions and the General Instructions prior to installing or operating this equipment.

- Blue Ox® towing products and accessories are intended to be installed by Blue Ox® Dealers who are familiar with our products and have the equipment and knowledge necessary to do "fit work". If needed, Blue Ox® Dealers can be found at www.blueox.com or by contacting our Customer Care Department at (402) 385-3051.
- Many Blue Ox® baseplates are designed to use existing holes and hardware to mount the baseplate to the towed vehicle. Even though bolts are there, do not assume they are adequate for baseplate mounting. Always use the hardware supplied in the hardware kit and existing hardware as specified in the installation instructions.



If the front of your vehicle looks different than this, please contact us at (402)385-3051.

Reference your vehicle owner's manual for manufacturer's towing specifications.

Bolt Torque Specifications

Torque in Foot-Pounds for Inch Bolts

Bolt Size	Grade 5	Grade 8
1/4"	10	14
5/16"	19	29
3/8"	33	47
7/16"	54	78
1/2"	78	119
5/8"	154	230
3/4"	257	380

Bolt Torque Specifications

Torque in Foot-Pounds for Metric Bolts

Bolt Size	Grade 8.8	Grade 10.9
6MM	6	8
8MM	16	22
10MM	31	40
12MM	54	70
14MM	89	117
16MM	161	230
18MM	222	318



WARNING

Failure to read and follow these instructions could result in separation of the towed vehicle from the tow bar, causing property damage, loss of towed vehicle, personal injury or death.

BX3833
2012-15 Volkswagen Passat SEL/SE (Includes TDI)
Installation Instructions

Removable Tabs: Use only with motorhome mount tow bars or the BX8833 or BX88151 adapters. Removable tabs with only one hole will not attach to car mount tow bars or other adapters. The Acclaim may only be used with removable tab baseplates that have 23" or greater spaced tabs. The Adventurer may only be used with baseplates that have 16" – 36" spaced removable tabs. The Ambassador may only be used with 24" spaced removable tabs.

Instruction Notes: The front fascia, front bumper, styrofoam bumper padding, headlights and temperature sensor are removed and reinstalled for the baseplate installation. Some drilling and trimming is required.

The dimensional variations between otherwise identical vehicles can be considerable. While the baseplate was designed for easy installation, it may be necessary to tailor the baseplate slightly to compensate for vehicle manufacturer's tolerances. These minor adjustments may include filing a hole slightly, bending electrical rods or bending end plates.

The BX8869 Tail Light Wiring Kit is recommended for this vehicle.



Drill a hole according to the tail light wiring kit instructions.

NOTICE

- Handling of some cosmetic parts when installing this product may require the use of protective covers, rags, specialty tools, etc. to prevent damage.
- When using power drills be aware of the dangers of torque and drill bit length.
- When using a reciprocating saw be aware of objects behind the cutting surface.
- Use a good quality paint to spray cut edges of frame to prevent rusting.
- Be sure that **ALL** electrical connections are plugged in and accessories are functioning properly before reinstalling the fascia.
- The baseplate is computer tested to your vehicle's GVWR, exceeding this weight will void the manufacturer's warranty.
- Be sure to use a sufficient amount of Loctite® Red on all bolt threads before tightening. Tighten all bolts according to the torque chart provided.
- Dealer or installer be certain the user receives these instruction sheets.
- If the baseplate is in an accident, it must be replaced. **DO NOT** use it again! An accident can cause unseen damage and using it again could result in more damage or serious injury. **DO NOT** use the baseplate if it is damaged or missing parts.

BX3833

2012-15 Volkswagen Passat SEL/SE (Includes TDI)

Installation Instructions

Tools Required

Large Vise Grip
 Flat Screwdriver
 Utility Knife
 Phillips Screwdriver
 Torque Wrench
 Drill
 Tape Measure
 Loctite® RED
 13/32" Drill Bit
 9/32" Drill Bit
 25 Torx
 9/16" Wrench

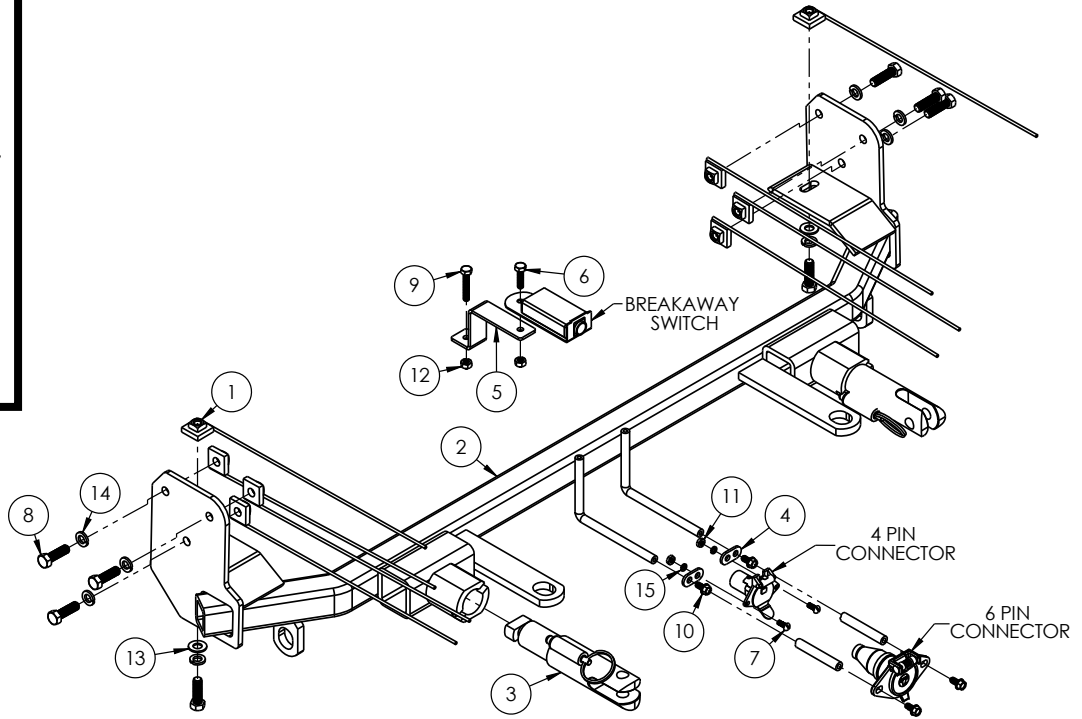

Item No.	Part No.	Description	Qty.
1.....	61-5208	3/8"-16 Nut Plate with 14" Wire	8
2.....	61-7044	BX3833 Baseplate.....	1
3.....	62-3468	Attachment Tab.....	2
4.....	101-5822	4 Way Connector Adapter	2
5.....	102-7353	Breakaway Bracket	1
6.....	201-0071	1/4"-20 x 1" Hex Head Bolt, Grade 5, ZP	1
7.....	201-0192	#10-32 1/2" Slotted Round Head Screw.....	2
8.....	201-0368	3/8"-16 x 1-1/4" Hex Head Bolt, Grade 5, ZP	8
9.....	201-0448	1/4"-20 x 1-1/2" Hex Head Bolt, Grade 5, ZP	1
10.....	201-0553	1/4"-20 x 1/2" Hex Wshd Type F TCS Screw	2
11.....	202-0047	#10-32 Hex Nut	2
12.....	202-0102	1/4"-20 Hex Nylon Nut, ZP	2
13.....	203-0003	3/8" Flat Washer, ZP.....	2
14.....	203-0010	3/8" Lock Washer, ZP	8
15.....	203-0054	#10 Lock Washer.....	2
16.....	226-0046(not shown)	Class III Safety Cables	2
17.....	229-0359(not shown)	3/8" Quicklink, ZP	4
18.....	290-0437(not shown)	Black Cap Plug Receiver.....	2
19.....	293-1339(not provided).....	Breakaway Switch	1
20.....	294-0805(not provided).....	4 Pin Connector.....	1
21.....	294-0902(not provided).....	6 Pin Connector.....	1

Important:

Use only genuine factory replacement parts on your baseplate. Do **NOT** substitute homemade or non-typical parts. If a bolt is lost or in need of replacement, for your safety and the preservation of your baseplate, be sure to use a replacement bolt of the same grade (In most cases it will be Grade 5, please reference the parts list above). Replacement parts may be ordered through your nearest Blue Ox® Dealer or Distributor. Failing to follow and/or altering these installation instructions in either installation or required equipment will void the manufacturer's warranty. Towing behind a non-motorized vehicle will void the warranty.

BX3833
2012-15 Volkswagen Passat SEL/SE (Includes TDI)
Installation Instructions

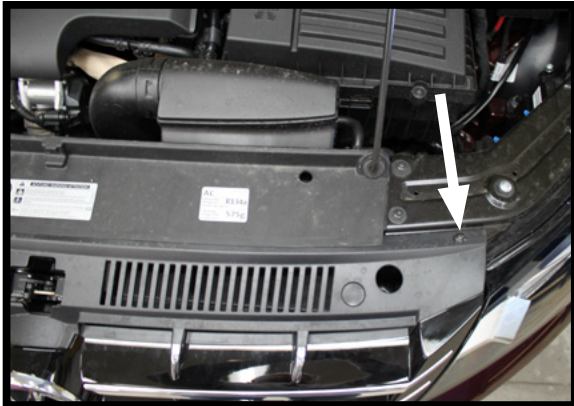

1. Using a Torx 25 remove the three (3) screws that are located in the front area, underneath the hood. There is one (1) screw located on the outer edge of the driver side and two (2) on the passenger side. On the passenger side, one (1) is located on the outer edge and the other is located just to the left of the center of the vehicle.

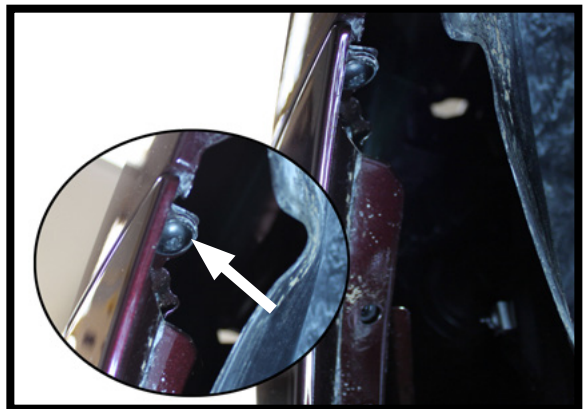
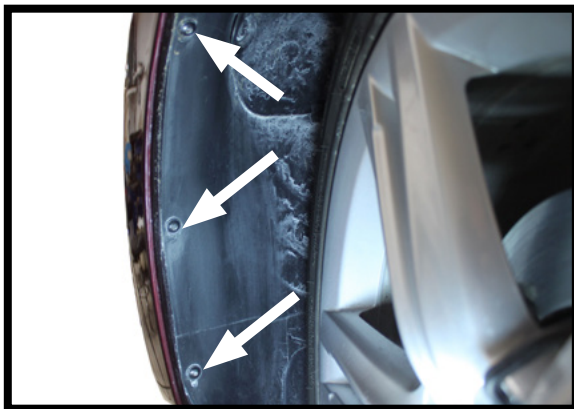

2. Remove the three (3) screws in the front wheel well area using a Torx 25. Do this on **BOTH** sides of the vehicle.
3. Pull the wheel well liner back. Using a Torx 25 remove the screw that is located underneath. Do this on **BOTH** sides of the vehicle.

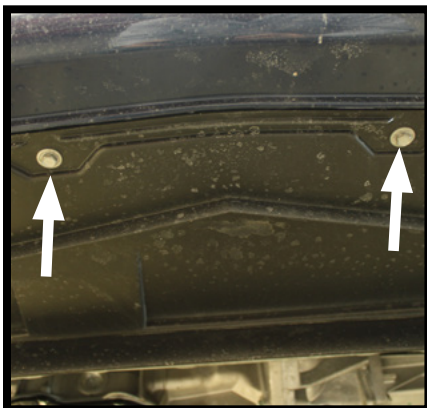

4. On the underside of the front fascia there are seven (7) screws that need to be removed using a Torx 25. There are three (3) on both the driver side and the passenger side, plus one (1) in the center of the vehicle.

BX3833
2012-15 Volkswagen Passat SEL/SE (Includes TDI)
Installation Instructions



5. Gently, yet firmly, pull outward on the front fascia to remove. Next, remove headlights on **BOTH** sides of the vehicle.

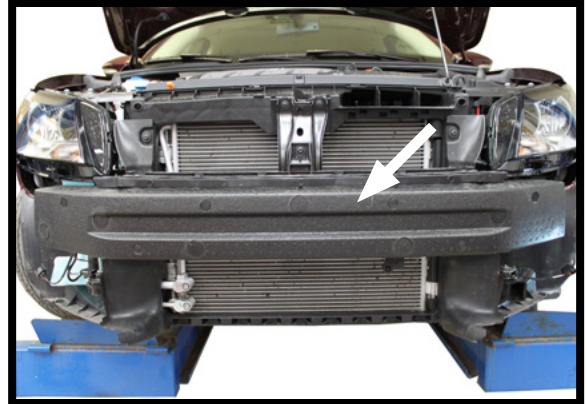

6. Pull the styrofoam bumper padding off and place to the side for reinstallation after the baseplate is installed.

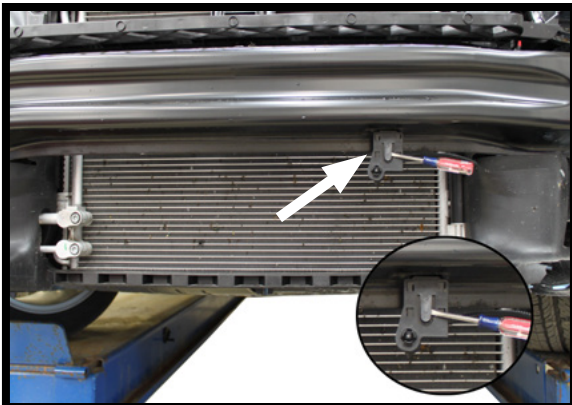

7. On the driver side, lift the tab up using a flat screwdriver and slide the temperature sensor off. Set aside for reinstallation later.

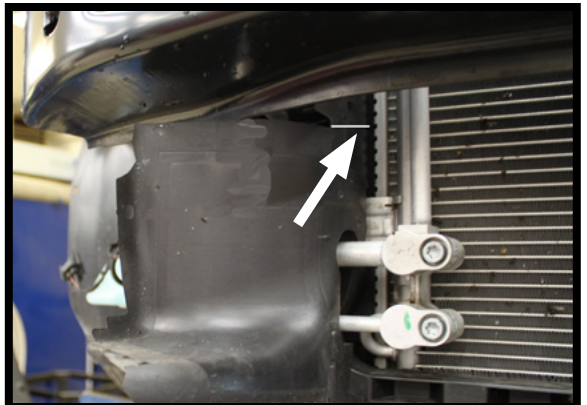

8. Cut straight across on the top of the plastic tab. After the cut has been made, lift up and remove the tab. Do this on **BOTH** sides.

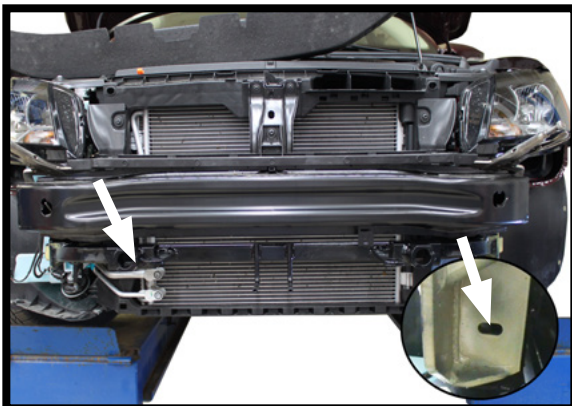

9. Place the baseplate under the bumper centering the slot on the bottom of the baseplate with the existing hole in the bumper. Securely clamp the baseplate into position. Take extra care on the passenger side not to hit the lines. NOTE: If the horn is in the way, gently bend it outward.

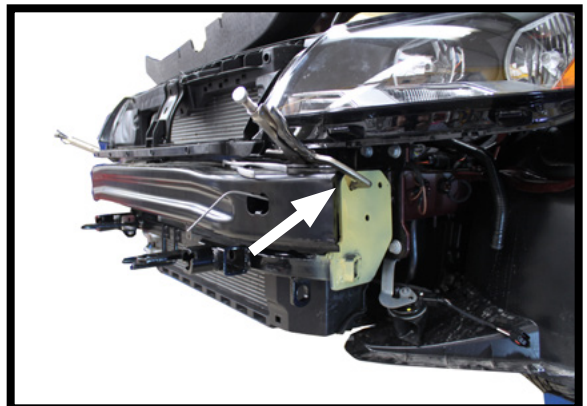

BX3833
2012-15 Volkswagen Passat SEL/SE (Includes TDI)
Installation Instructions

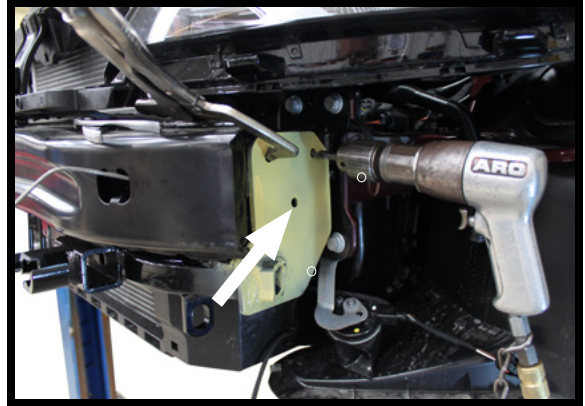
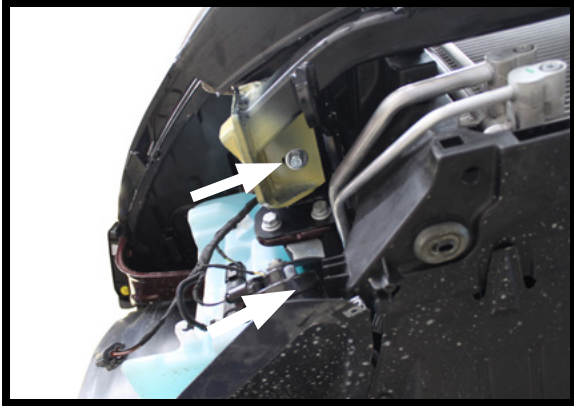

10. Verify the baseplate is level and install the 3/8"-16 x 1-1/4" hex head bolts, 3/8" lock washers and 3/8" flats washers on the bottom slot. Do this on **BOTH** sides of the vehicle.

11. Using a 13/32" drill bit and using the baseplate as a template, drill the three (3) sides holes. Do this on **BOTH** sides of the vehicle.

12. Reattach the temperature sensor and front bumper padding.

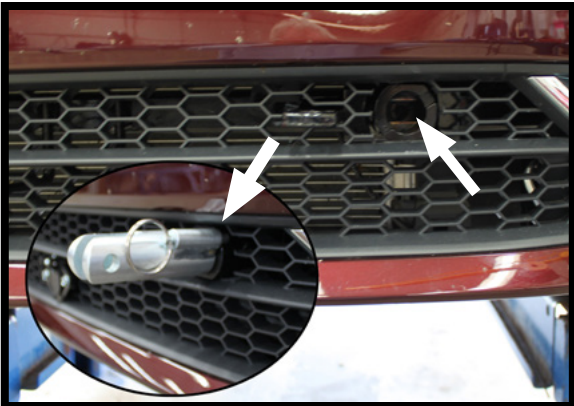

13. Hold the front fascia as close to the original state as possible and mark where the cutout for the convenience links, attachment tabs and breakaway switch, is so equipped, will be located.

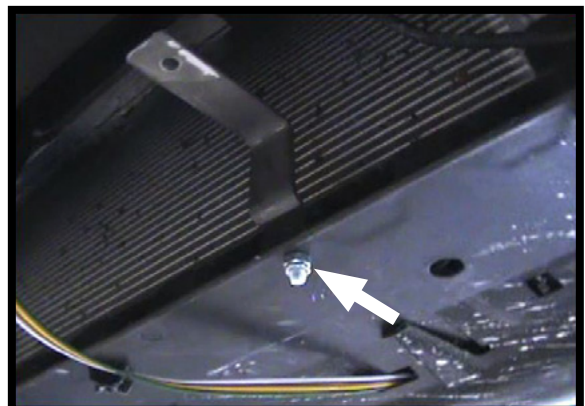

14. You may place the breakaway bracket anywhere on the vehicle frame. Using a 9/32" drill bit, drill a hole into the frame.

Set the front fascia down and notch the grill to allow for proper clearance.

BX3833
2012-15 Volkswagen Passat SEL/SE (Includes TDI)
Installation Instructions



15. Attach the permanent baseplate safety cables to the provided convenience link on the baseplate. The photo above shows the recommended installation of the cables to frame of vehicle. Additional options may interfere with suggested mounting; in this case, secure the cables to a solid piece of the frame as described in the instructions included with the permanent baseplate safety cables. Be sure the safety cables do not rub against any hoses or moving parts. Do this on **BOTH** sides of the vehicle.

16. Reinstall front fascia.

CUSTOMER SERVICE COMMITMENT

Blue Ox® is committed to providing you with exceptional customer care throughout your lifetime with our products. Our team is here to assist you with any questions you may have regarding the performance of your product. Simply call (402) 385-3051 and you can speak with our customer care team.

Additionally, please visit our website to see which rallies our Destination America team will be attending. For a nominal fee, our service technician will service your towing system to ensure it's in proper working condition. Also, as a commitment to our customers, should you visit our factory, you can stay at our full service Blue Ox® campground at no charge along with enjoying a factory tour.

Again, thank you for being our customer and for the confidence you have shown in the performance of our products. It is because of customers like you we enjoy the success we have today.

© 2013 Blue Ox
One Mill Road, Industrial Park
Pender, Nebraska 68047
Phone: (402) 385-3051
Fax: (402) 385-3360
www.blueox.com