



BX1670

2006-13 Chevy Impala
2006-07 Chevy Monte Carlo
Installation Instructions

Serial Number

Please read **BOTH** these Installation Instructions and the General Towing Instructions before attempting to install or operate this equipment.

- Blue Ox® towing products and accessories are intended to be installed by Blue Ox® Dealers who are familiar with our products and have the equipment and knowledge to do “fit work”. When necessary, Blue Ox® Dealers can be found at www.blueox.com or by contacting our Customer Care Department at (402) 385-3051.
- Many Blue Ox® Baseplates are designed to use existing holes and hardware to mount the baseplate to the towed vehicle. Even though bolts are there, do not assume they are adequate for baseplate mounting. Always use hardware supplied in the hardware kit or existing hardware specified in the Baseplate Installation Instructions.

Attachment Tab Height: 13 3/4”
Attachment Tab Width: 24”

Bolt Torque Specifications
Torque in Foot-Pounds for Metric Bolts

Bolt Size	Grade 8.8	Grade 10.9
6MM	6	8
8MM	16	22
10MM	31	40
12MM	54	70
14MM	89	117

Confirm the towability and pre-towing procedures for your vehicle with the owner’s manual or contact the vehicle’s manufacturer for specific towing procedures.

Bolt Torque Specifications
Torque in Foot-Pounds for Inch Bolts

Bolt Size	Grade 5	Grade 8
1/4”	10	14
5/16”	19	29
3/8”	33	47
7/16”	54	78
1/2”	78	119
5/8”	154	230



If the front of your vehicle looks different than this, call us at (402) 385-3051.

⚠ WARNING

Failure to read and follow these instructions could result in separation of the towed vehicle from the tow bar, causing property damage, loss of towed vehicle, personal injury or death.



BX1670

2006-13 Chevy Impala
 2006-07 Chevy Monte Carlo
 Installation Instructions

Parts List

Ref. No.	Qty.	Part #	Description
1	1	61-6315	Weldment, Base Plate, BX1670
2	8	61-5208	3/8" Nut Plate, with Wire
3	8	201-0440	3/8-16 x 1 1/2" Hex Bolt, Grd. 5, ZP
4	8	203-0010	3/8" Lock Washer, ZP
5	2	201-0979	#12-14 x 1" Self Drilling Screw, ZP
6	2	201-0192	#10-32 x 1/2" Slot, Rd. Hd. Screw
7	2	203-0054	#10 Lock Washer
8	2	202-0047	#10-32 Hex Nut
9	2	101-5822	Adapter, 4 Way Connector
10	2	62-3469	Attachment, Assembly, SF/LB (R)
	2	226-0046	Baseplate Safety Cable, 36" CL III (Not Shown)
	4	229-0359	Quicklink, 3/8, ZP (Not Shown)
	2	290-0437	Cap Plugs, Black (Not Shown)

Tools Required

- Loctite® RED
- 7mm Socket
- 10mm Deep Well Socket
- 9/16" Socket
- 13/32" Drill Bit
- Hack Saw Blade
- Reciprocating Saw
- Utility Knife
- Vise Grips

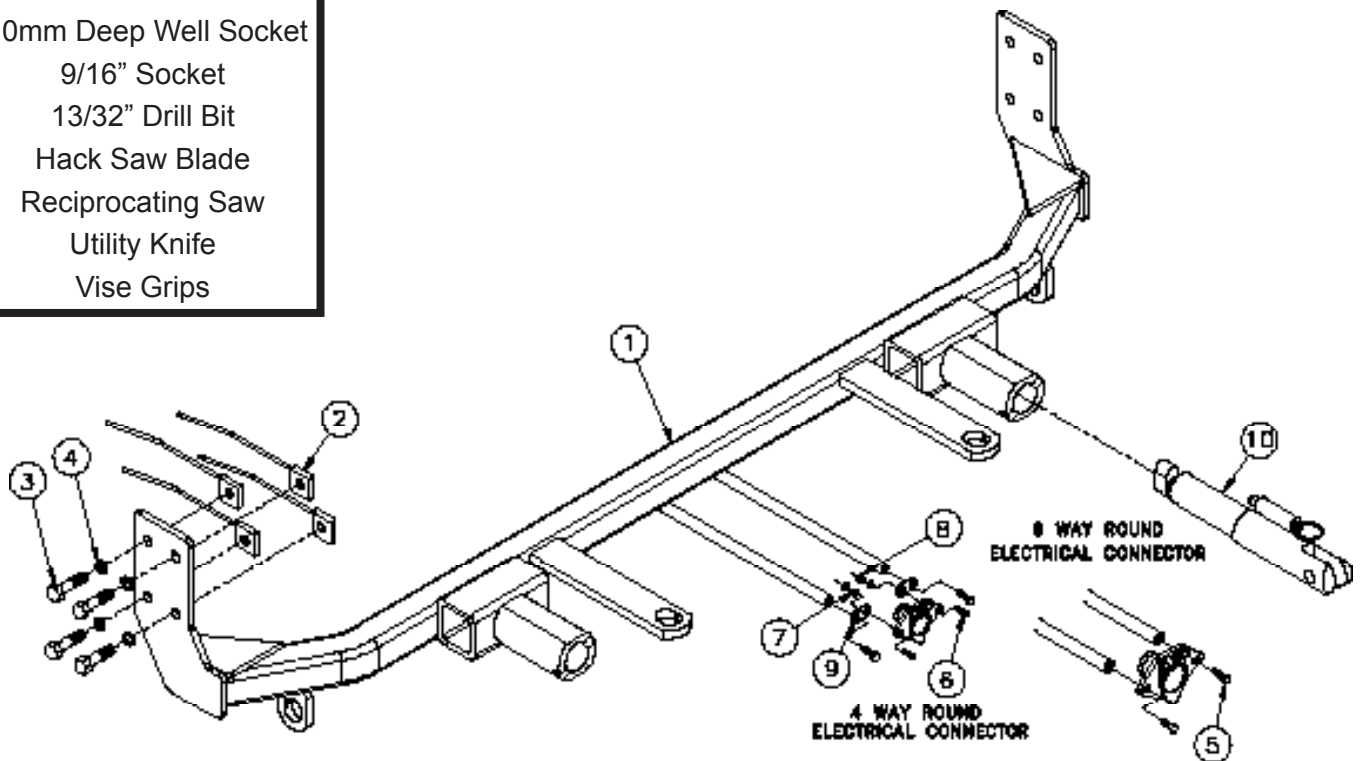

Important:

Use only genuine factory replacement parts on your baseplate. Do **NOT** substitute homemade or non-typical parts. If a bolt is lost or in need of replacement, for your safety and the preservation of your baseplate, be sure to use a replacement bolt of the same grade (In most cases it will be Grade 5, please reference the parts list above). Replacement parts may be ordered through your nearest Blue Ox® Dealer or Distributor. Failing to follow and/or altering these installation instructions in either installation or required equipment will void the manufacturer's warranty. Towing behind a non-motorized vehicle will void the warranty.



BX1670

2006-13 Chevy Impala
2006-07 Chevy Monte Carlo
Installation Instructions

Attachment Tabs:

Due to the design of the removable tabs, the RangeFinderII tow bar can not be used. Adapters, except the BX8833 and BX88151, can not be used with this baseplate.

Installation Notes: The fascia, horn, washer reservoir, belly pan and air dams are removed for installation. Air dams are not reinstalled. The grille style, belly pan and bumper bracket are trimmed. Drilling is required.

The dimensional variations between otherwise identical vehicles can be considerable. While the baseplate was designed for easy installation, it may be necessary to tailor the baseplate slightly to compensate for auto manufacturer's tolerances. These minor adjustments may include filing a hole slightly, bending electrical rods or bending end plates.

The BX8869 Bulb and Socket Wiring Kit is recommended for this vehicle.



Possible Location for the BX8869 Bulb and Socket Wiring Kit.

Installation Instructions:

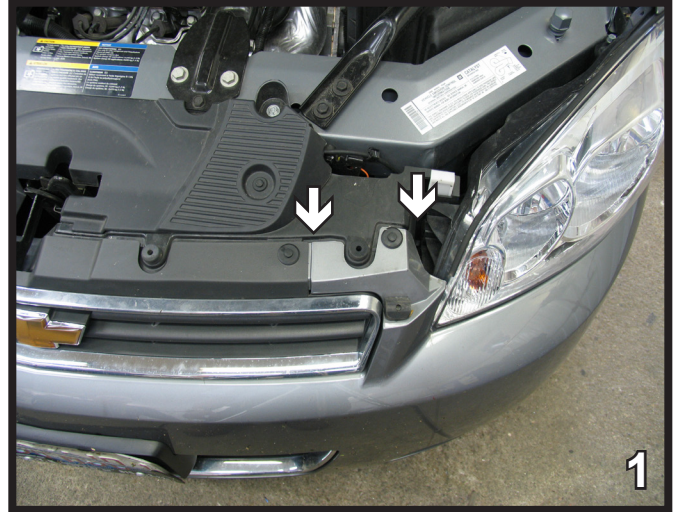

1. Remove two push pins from the top corner of fascia. Do this to both sides of the vehicle. Set push pins aside to be reinstalled later.



2. Just inside wheel well, on edge of fascia, remove three push pins. Do this to both sides of the vehicle. Set push pins aside to be reinstalled later.

Handling of some cosmetic parts when installing this product may require the use of protective covers, rags, specialty tools, etc. to prevent damage.

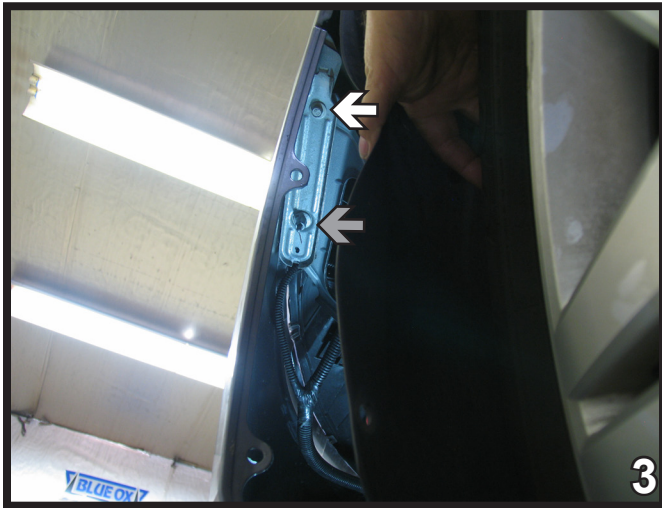

3. Push wheel well cover aside, remove the upper metric bolt (see white arrow) and loosen, do not remove, the lower metric bolt (see grey arrow) using the 10mm deep well socket. Do this to both sides of the vehicle. Set bolts aside to be reinstalled later.



4. Using the 7mm socket, remove two metric bolts from underside of fascia, just forward of front tire. Do this to both sides of the vehicle. Set bolts aside to be reinstalled later.

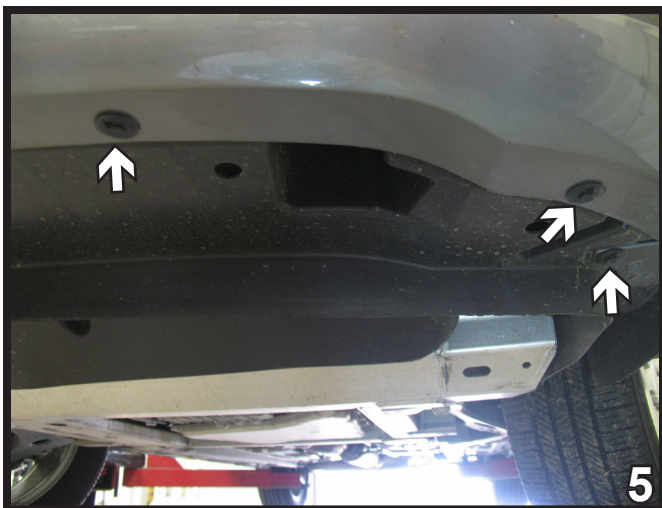

5. Remove three push pins from bottom corner of fascia. Do this to both sides of the vehicle. Disconnect fog lights. Pull fascia forward to remove. Set push pins and fascia aside carefully to be reinstalled later.



6. Just forward of the front tire, on the wheel well, remove two Christmas tree push pins. Do this to both sides of the vehicle. Set push pins aside to be reinstalled later.



BX1670

2006-13 Chevy Impala
2006-07 Chevy Monte Carlo
Installation Instructions



7. Using the 10mm socket, remove three metric bolts from the bottom of the belly pan. Set bolts aside to be reinstalled later.

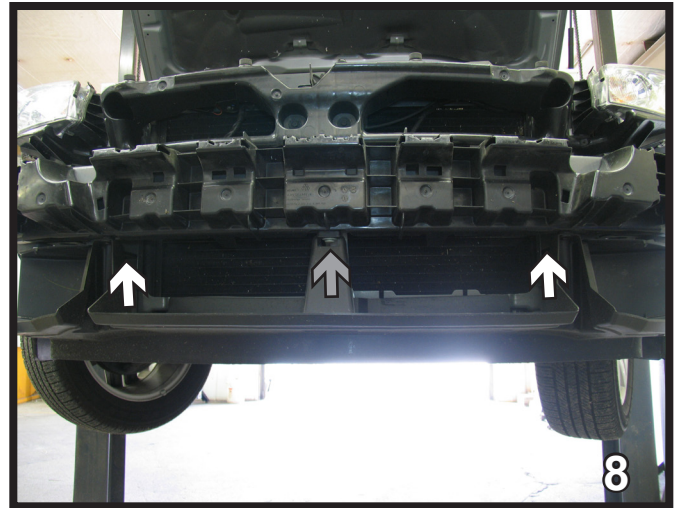

8. Remove two push pins from the belly pan extensions (see white arrows). Pull forward on the center extension (see grey arrow) to remove the belly pan. Set belly pan and push pins aside to be reinstalled later.

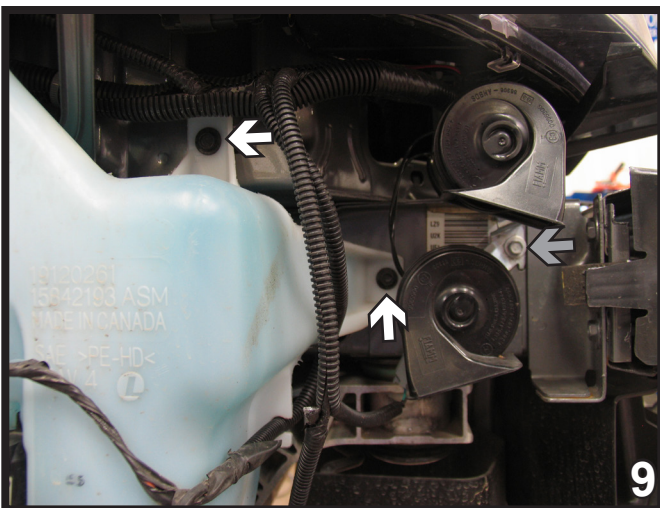

9. On the passenger's side, disconnect and plug the washer reservoir. Remove two metric bolts from the washer reservoir (see white arrows) and one metric bolt from the horn bracket (see grey arrow) using the 10mm socket. Set horn and bolts aside to be reinstalled later.

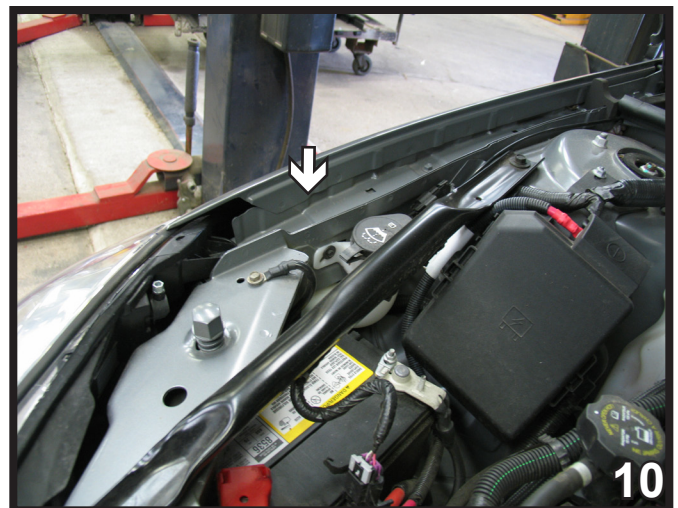

10. From the top of the washer reservoir, near the battery, remove one metric bolt using the 7mm socket. Remove reservoir. Set bolt and reservoir aside to be reinstalled later.



BX1670

2006-13 Chevy Impala
2006-07 Chevy Monte Carlo
Installation Instructions

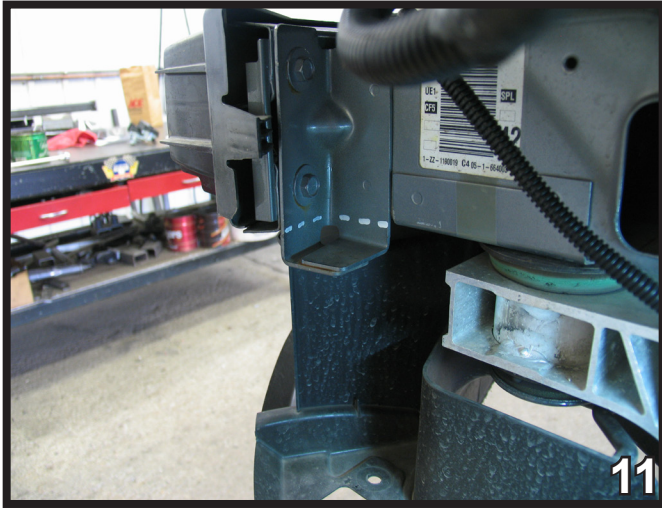

11. Using the reciprocating saw, mark and cut the bottom of the bumper bracket so that it is flush with the bottom of the frame rail. Do this to both sides of the vehicle.

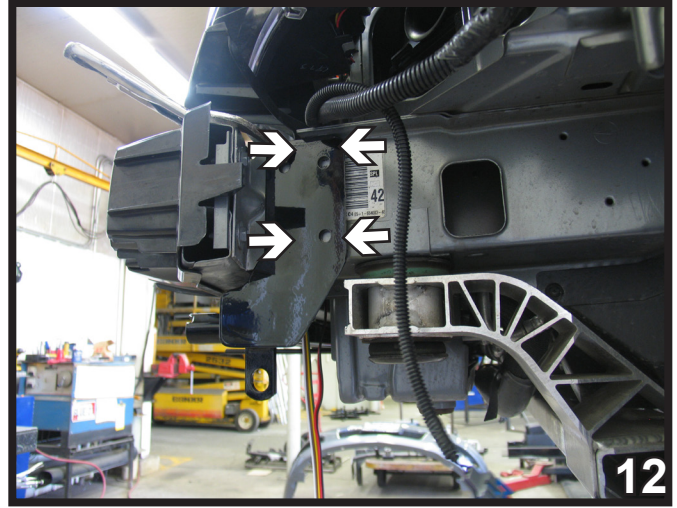

12. Align the baseplate with the webbing at the top of the frame rail and the contour on the back edge of the frame rail. Clamp in place with the vise grips. Using baseplate as a template, drill four holes into the frame rail using the 13/32" drill bit. Do this to both sides of the vehicle.

When using power drills be aware of the dangers of torque and drill bit length.



13. Insert 3/8" nut plates through opening in side of frame rail. Align to drilled holes. Install 3/8-16 x 1 1/2" hex bolts with 3/8" lock washers and tighten to nut plates. Use Loctite Red on all bolts. Trim excess nut plate wires. Do this to both sides of the vehicle.

BE SURE TO USE LOCTITE® RED ON ALL BOLTS BEFORE TIGHTENING. TIGHTEN ALL BOLTS ACCORDING TO THE TORQUE CHART ON THE FRONT PAGE OF THESE INSTRUCTIONS OR ON PAGE 3 OF THE BASEPLATE TOWING GENERAL INSTRUCTIONS.



14. Remove the two air dams from the belly pan. The air dams will not be reinstalled. Hold belly pan up to its original position and mark the area where the back of the belly pan extensions meet the cross tube of the baseplate. Lay the belly pan on a smooth flat surface and, using the utility knife, cut the marked area. It will measure approximately 2 1/2" x 2 1/2".



BX1670

2006-13 Chevy Impala 2006-07 Chevy Monte Carlo Installation Instructions

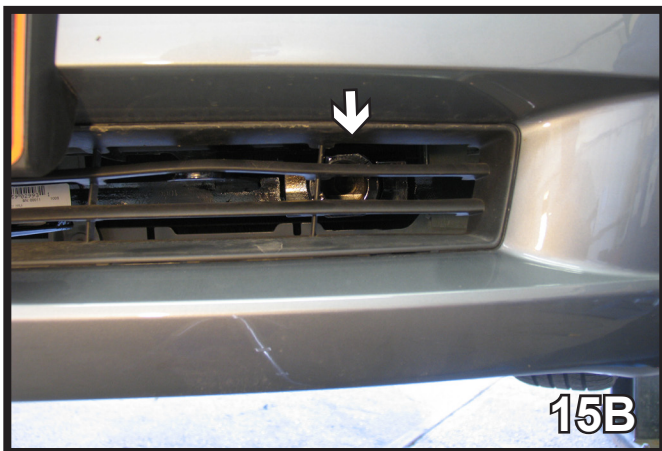

15. Align the fascia to its original position and, using the hack saw blade, trim necessary openings in the grille style for the attachment tabs. Photo 15A shows the '06 Chevy Impala and photo 15B shows the '06 Chevy Monte Carlo. Do this to both sides of the vehicle.

Be sure that **ALL** electrical connections are plugged in properly and functioning **BEFORE** installing the fascia.

16. Reinstall the horn, washer reservoir, belly pan, fascia, pushpins and bolts.

Install the tow bar and safety cables according to the instructions provided in their packages. When demonstrating this to the customer, be sure to include all the contents and packages.

Do **NOT** substitute other devices if the tow bar pins and clips are misplaced.

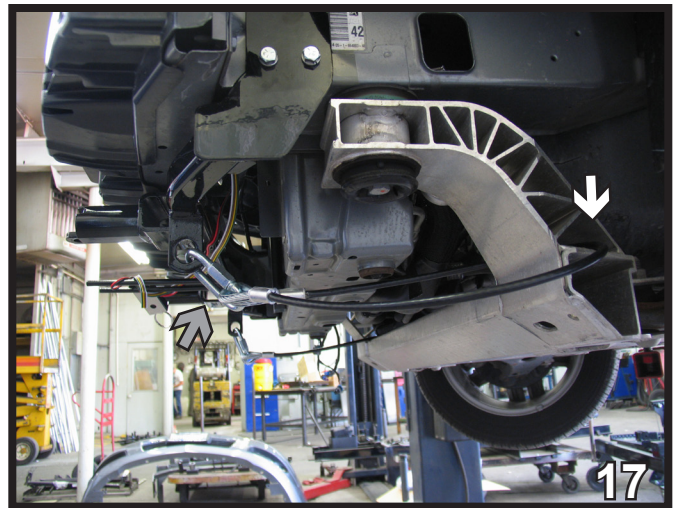

17. Attach the permanent baseplate safety cables to the provided convenience link on the baseplate (see grey arrow). The photo above shows the recommended installation of the cables to frame of vehicle (see white arrow). Additional options may interfere with suggested mounting; in this case secure the cables to a solid piece of the frame as described in the instructions included with the permanent baseplate safety cables. Be sure the safety cables do not rub against any hoses or moving parts. Do this to both sides of the vehicle.



BX1670

2006-13 Chevy Impala
2006-07 Chevy Monte Carlo
Installation Instructions

DEALER or INSTALLER:

Be certain the user receives the instruction sheets for their products.



Shown without removable tabs installed.



Shown with removable tabs installed.

If the baseplate is in an accident, it must be replaced. DO NOT use it again! An accident can cause unseen damage and using it again could result in more damage or serious injury. DO NOT use the baseplate if it is damaged or missing parts.

CUSTOMER SERVICE COMMITMENT

Blue Ox is committed to providing you with exceptional customer care throughout your lifetime with our products. Our team is here to assist you with any questions you may have regarding the performance of your product. Simply call 1-402-385-3051 and you can speak with our customer care team.

Additionally, please visit our website to see which rallies our Destination America team will be attending. For a nominal fee, our service technician will service your towing system to ensure it's in proper working condition. Also as a commitment to our customers, should you visit our factory you can stay at our full service Blue Ox campground at no charge along with enjoying a factory tour.

Again thank you for being our customer and for the confidence you have shown in the performance of our products. It is because of customers like you we enjoy the success we have today.



© 2012 Blue Ox
One Mill Road, Industrial Park
Pender, Nebraska 68047
Phone: (402) 385-3051 • Fax: (402) 385-3360
www.blueox.com
8/24/12