

DuraLITE 100-WATT PORTABLE SOLAR KIT

User Manual

GP-DURALITE-100
GP-DURALITE-100E



GP-DuraLITE-100E does not
include a solar controller

© 2022 Go Power!

Worldwide Technical Support and Product Information gpelectric.com

Go Power! | Dometic

201-710 Redbrick Street Victoria, BC, V8T 5J3

Tel: 1.866.247.6527

MAN_DURALITE-100-100E-PSK_RevA



2. GENERAL INFORMATION4

 2.1 USES4

 2.1 WARNINGS4

3. FEATURES5

 3.1 DuraLITE-100 BASE KIT5

 3.2 DuraLITE-100E EXPANSION KIT6

 3.1 ADDITIONAL ACCESSORIES SOLD SEPARATELY7

4. PANEL SPECIFICATIONS7

5. SET UP7

6. 30-AMP SOLAR CONTROLLER8

 6.1 SOLAR CONTROLLER SPECIFICATIONS8

 6.2 SOLAR CONTROLLER WARNINGS9

7. CHOOSING A BATTERY9

8. SOLAR CONTROLLER OPERATING INSTRUCTIONS10

9. LED INDICATORS11

10. BATTERY CHARGING PROFILE CHART11

11. ERRORS AND TROUBLESHOOTING13

12. DISPLAY SYMBOLS14

13. FREQUENTLY ASKED QUESTIONS13

14. TROUBLESHOOTING15

 14.1 PROBLEMS WITH CONTROLLER DISPLAY15

 14.2 PROBLEMS WITH VOLTAGE16

 14.3 PROBLEMS WITH CURRENT17

15. EXPANSION CONNECTION & WIRING DIAGRAM18

 15.1 CONNECTING EXPANSION KIT(S)18

 15.2 WIRING DIAGRAM18

16. LIMITED WARRANTY19

Welcome to the Go Power! DuraLITE Portable Solar Kit User Manual. Please read all instructions contained within this manual to gain a full understanding of how to deploy, hook-up, and use this product.

Please visit support.gpelectric.com for the most current version of this manual.

Veillez visiter support.gpelectric.com pour la version française de ce manuel de l'utilisateur

Visite support.gpelectric.com para la versión en español de este manual del usuario

2.1 USES

The GP-DuraLITE-100 features an integrated 30-amp solar controller and is meant for use with pre-wired RVs and other unregulated charging applications. It is expandable up to 300 watts by connecting up to two expansion kits (GP-DuraLITE-100E). The expansion kits do not include the solar controller.







GP-DuraLITE-100 - this kit IS NOT meant for use with a portable power station, unless the controller is disconnected.



GP-DuraLITE-100E - this kit IS compatible with a portable power station.



2.2 WARNINGS

	This kit IS NOT weatherproof	Never leave your DuraLITE Solar Kit unattended, plugged in overnight, or subject to inclement weather.
	Use caution around power sources	Electricity can be very dangerous. Take appropriate caution when making connections.
	Battery and wiring safety	Observe all safety precautions of the battery manufacturer when handling or working around batteries. When charging, batteries produce hydrogen gas, which is highly explosive. Ensure batteries are in a well-ventilated space, away from sparks for open flames.
	Wiring connections	Ensure all connections are tight and secure. Loose connections may generate sparks and heat. Be sure to check all connections before using the portable solar kit.
	Observe correct polarity	Reverse polarity of the battery terminals and array will cause the controller to give a warning tone. The controller will not function unless battery terminals are connected to a battery with proper polarity. Failure to correct this fault could damage the controller.
	Do not exceed the Charge Controller current and voltage ratings	Refer to charge controller section for details.

3. FEATURES

3.1 DuraLITE-100 BASE KIT

	Description
1	Handle
2	Foldable legs
3	Solar charge controller
4	USB ports & LED indicator
5	DC output port
6	Battery clamps
7	Quick connect dust cover
8	SAE Solar Plug (for connecting to RVs)
9	Ring terminals (for permanent mounting)
10	2-Pin XLR Connector to Anderson Connector
11	Expansion Connection Cable

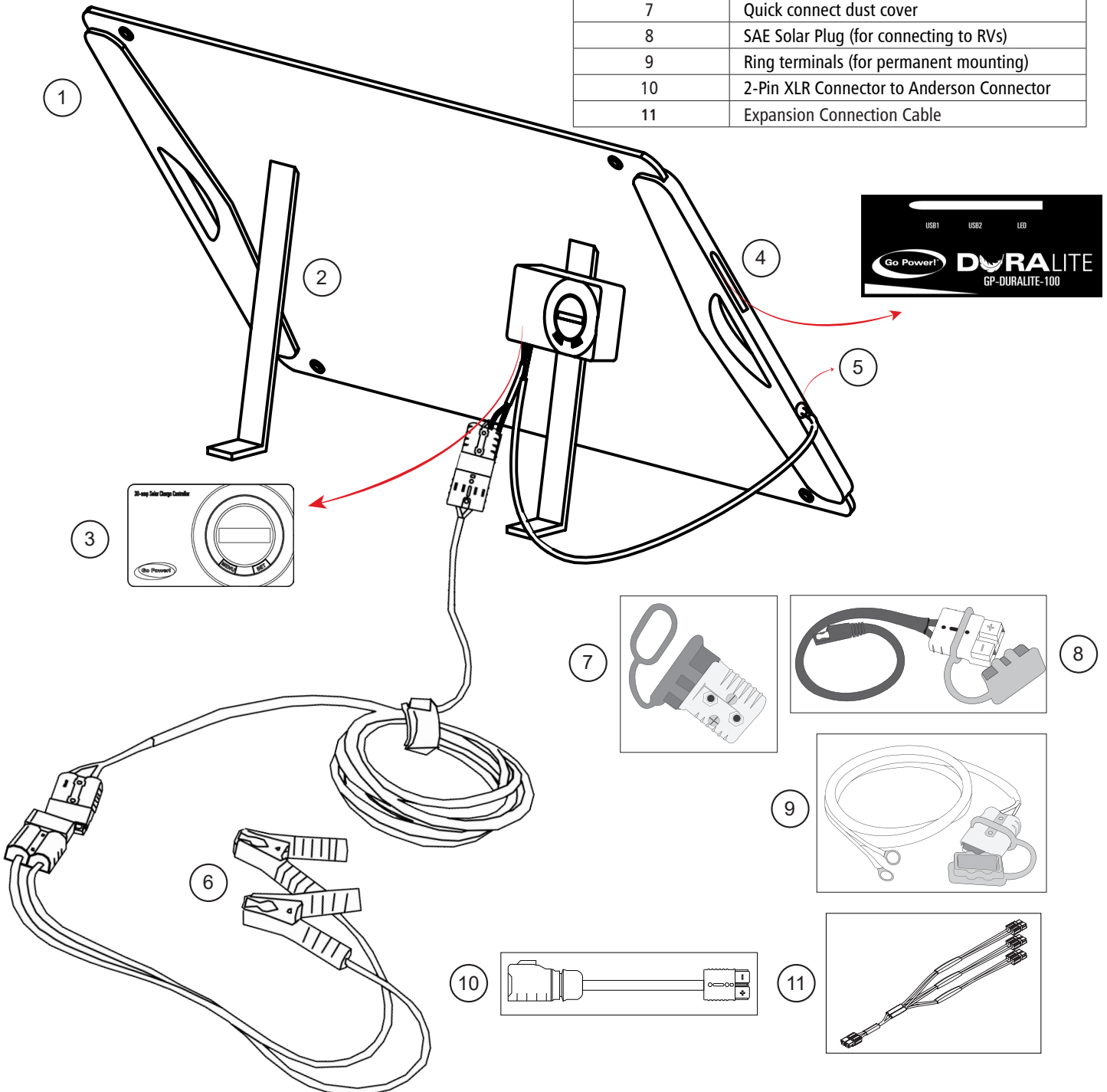

3.2 DuraLITE-100E EXPANSION KIT

	Description
1	Handle
2	Foldable legs
3	USB ports & LED indicator
4	DC output port
5	2x Extension Cable
6	Barrel Connector (for connecting to portable power stations)
7	MC4 Connector (for connecting to portable power stations)

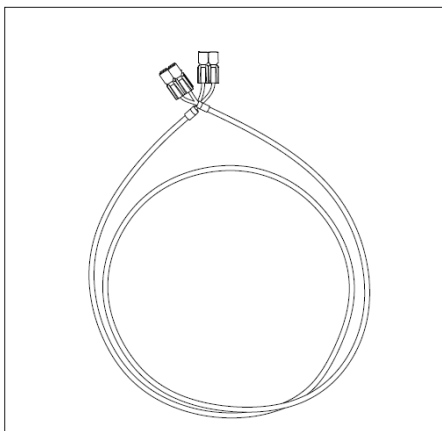
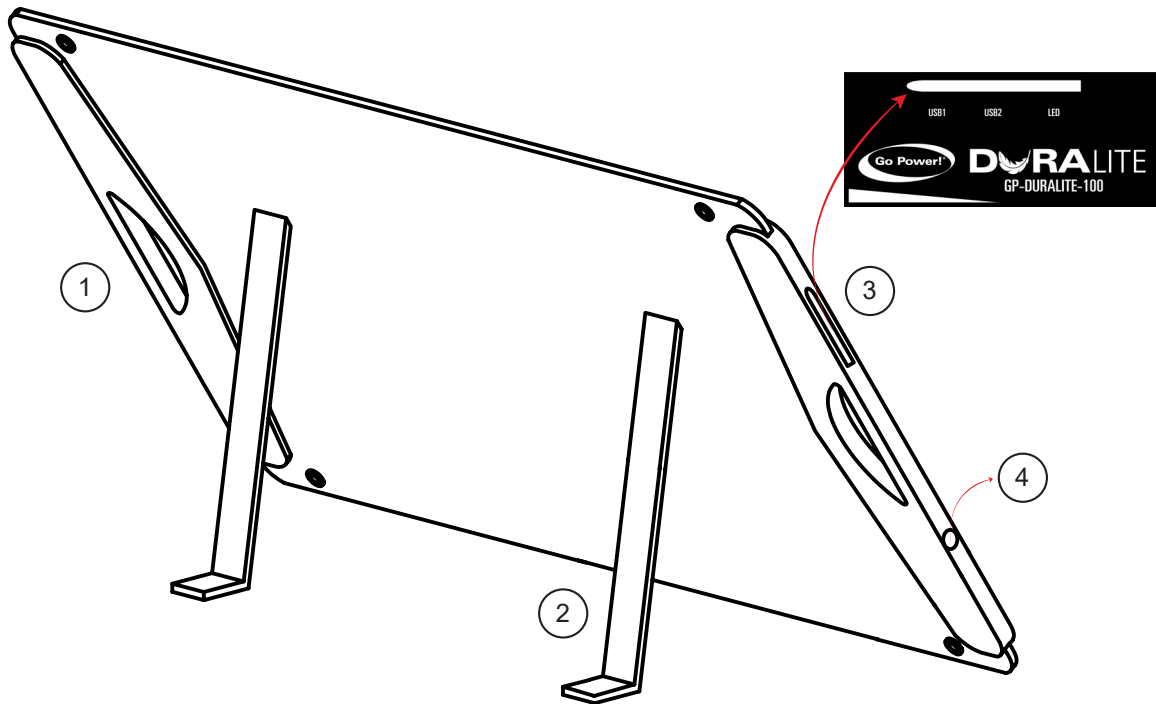

5

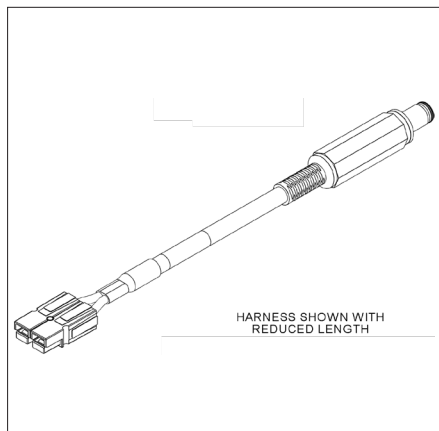

6

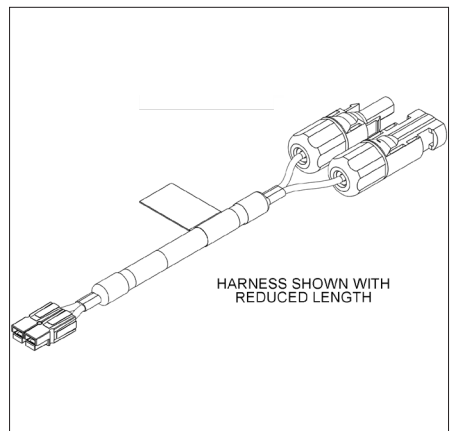

7

4. PANEL SPECIFICATIONS

3.3 ADDITIONAL ACCESSORIES SOLD SEPARATELY

Visit gpelectric.com for product details.

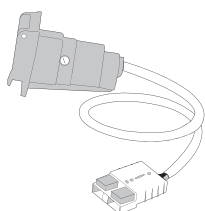

GP-PSK-7PIN
7 Pin Trailer Plug Adapter
Use your existing trailer plug to access your battery for charging.

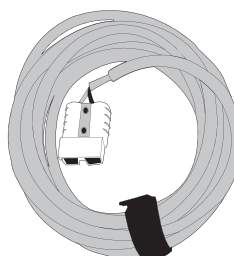

GP-PSK-X30
30' Extension Cable
Park your RV in the shade and place your solar panel in the sun using this extension cable.

4. PANEL SPECIFICATIONS

TYPE	MODULE SIZE (CLOSED)	MODULE SIZE (OPENED)	NET WEIGHT	MAX POWER	MAX POWER VOLTAGE	MAX POWER CURRENT
Module	(H) x (W) x (D)	(H) x (W) x (D)	lbs / kg	W	V	A
100W (2x50W)	21.1 x 23.8 x 1.8 in 536 x 604.5 x 45.7 mm	21.1 x 47.6 x 0.9 in 536 x 1209 x 23 mm	8.4 lbs / 3.8 kg	100	19.8	5.06

5. SET-UP

1. Locate a sunlit area, free from overhanging branches or obstructions.
2. Remove solar panel kit from carrying case.
3. Unclip the two latches on the side of the unit and fold the two panels outward. Extend the two support legs to their maximum length and lock in position.
4. Place solar panel facing the sun.

Note

Avoid any shading no matter how small. An object as small as a broomstick held across the solar module may cause the power output to be reduced. Overcast days may also cut the power output of the module.

To obtain maximum output it is suggested that the panel's direction be frequently adjusted to track the sun's movement throughout the day (southerly exposure).

Note

Stabilize the panel by inserting a tent peg into the grommet hole at the base of each leg.

5. Connect battery clamps to the positive (red, +) and negative (black, -) battery terminals. Ensure that the connection is secure. Connect the battery clamp cable to the rest of the solar panel cable using the quick connect cable.



Ensure the battery clamps do not come in contact with one another.

Do not let water come into contact with the controller.







Do not leave the DuraLITE kit outside overnight or during inclement weather.

6.1 SOLAR CONTROLLER SPECIFICATIONS

DESCRIPTION	VALUE	DIMENSIONS (H X W X D):
Nominal System Voltage	12 VDC	Dimensions (H x W x D): 178.5 × 105.5 × 48.3mm 7.02 x 4.15 x 1.90 in Weight: 300g / 10.6 oz Recommended Wire Gauge: #8 AWG Warranty: 5 years <ul style="list-style-type: none"> • PWM Charging • 4 Battery Charging profiles • 4 Stage Charging • Displays Charging Current, Battery Voltage and Battery State of Charge • Reverse Polarity protected • Temperature Compensated • RoHS Compliant, environmentally safe • Accepts up to 3 DuraLITE Kits (300 watts of solar at 12 volts)
Range of Battery Input Voltage	8 ~ 32 VDC	
Rated Charge Current	30A	
Charging Output DC Voltage Range	9 – 14.9 VDC	
Max. PV Short Circuit Current	30A	
Max. PV Open Circuit Voltage	50V	
Operating Consumption (Display backlight on)	15 mA	
Operating Consumption (Display backlight off)	6 mA	
Charge Circuit Voltage Drop	0.21V	
Battery Types Supported	Sealed, Gel, Flooded, Lithium 1, and Lithium 2	
Self-consumption	≤4.2mA/12V; ≤2.6mA/24V	
Temperature Compensation	-3mV/°C/2V(Default)	
Protection	Battery Reverse Polarity, PV Reverse Polarity, Over Temperature, PV Short Circuit, PV Over Current, PV Over Voltage,	

6.2 SOLAR CONTROLLER WARNINGS

	<p>This kit IS NOT weatherproof</p>	<p>Never leave your DuraLITE Solar Kit unattended, plugged in overnight, or subject to inclement weather.</p>
--	--	---

	Use caution around power sources	Electricity can be very dangerous. Installation should be performed only by a licensed electrician or qualified personnel.
	Battery and wiring safety	Observe all safety precautions of the battery manufacturer when handling or working around batteries. When charging, batteries produce hydrogen gas, which is highly explosive. Ensure batteries are in a well-ventilated space, away from sparks for open flames.
	Wiring connections	Ensure all connections are tight and secure. Loose connections may generate sparks and heat. Be sure to check all connections before using the portable solar kit.
	Observe correct polarity	Reverse polarity of the battery terminals and panel will cause the controller to give a warning tone. The controller will not function unless battery terminals are connected to a battery with proper polarity. Failure to correct this fault could damage the controller.
	Work safely	Wear protective eyewear and appropriate clothing during installation. Use extreme caution when working with electricity and when handling and working around batteries.
	Do not exceed the SOLAR CONTROLLER max current ratings	The maximum current of the solar system is the sum of parallel-connected PV module-rated short circuit Currents (Isc) multiplied by 1.25. The resulting system current is not to exceed 37.5A. If your solar system exceeds this value, contact your dealer for a suitable controller alternative.
	Do not exceed max voltage ratings	The maximum voltage of the panel is the sum of the PV module-rated open-circuit voltage of the series connected modules multiplied by 1.25 (or by a value from NEC 690.7 provided in Table 690.7 A). The resulting voltage is not to exceed 35V. If your solar system exceeds this value, contact your dealer for a suitable controller alternative.

7. CHOOSING A BATTERY

The SOLAR CONTROLLER is suitable for use with lead acid batteries (vented, GEL, or AGM type) as well as some lithium iron phosphate (LiFePO4) batteries that are supplied with a Battery Management System (BMS). No other chemistries (including Lithium-Ion) are compatible with this controller.

Lithium batteries typically have maximum allowed charge currents. These maximums typically decrease in cold temperatures. SOLAR CONTROLLER does not limit current for these restrictions, and system design of the solar panel must account for this.

Be sure to follow all battery manufacturer safety instructions.

8. SOLAR CONTROLLER OPERATING INSTRUCTIONS

The SOLAR CONTROLLER Maximum 37.5A rating is based on a 30-amp total maximum short circuit current rating (Isc) from the solar modules nameplate ratings. The National Electric Code specifies the PV equipment/system rating to be 125% of the maximum Isc from the PV module ratings (1.25 times 30 = 37.5A). E.G. Three modules in parallel with an Isc of 7 amps each equal a total Isc input of 21 amps. When selecting PV modules for use with the SOLAR CONTROLLER do not exceed a total nameplate Isc current of 30A. Solar modules list the Isc amps on their nameplate label.

Note

The controller will not work unless there is a battery connected to the Battery 1 terminals.



WARNING: When the photovoltaic (solar) panel is exposed to light, it supplies a dc voltage to this equipment.

8. SOLAR CONTROLLER OPERATING INSTRUCTIONS

1) Automatic cycle interface

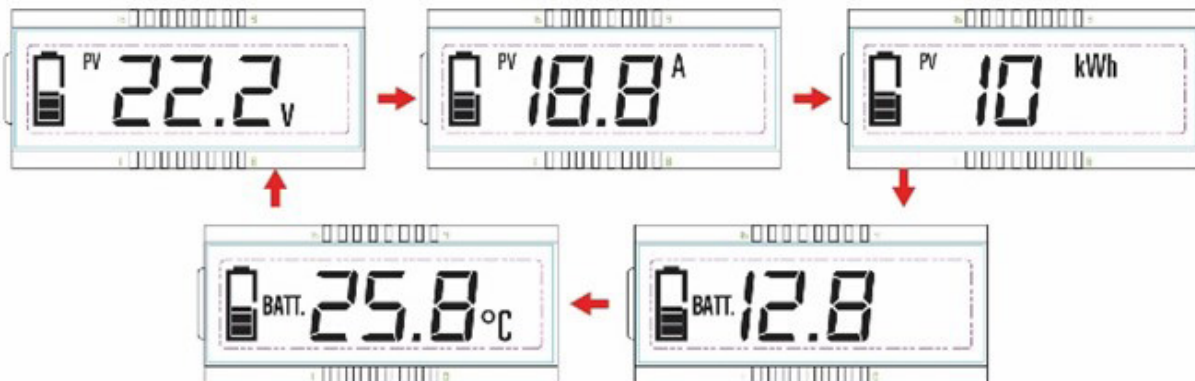

Display: PV voltage, PV current, PV power, Battery voltage and Battery temperature

2) Clear the generated energy

Operation:

Step 1: Press the "SET" button and hold 5s under the PV power interface and the value is flashing.

Step 2: Press the "SET" button to clear the generated energy

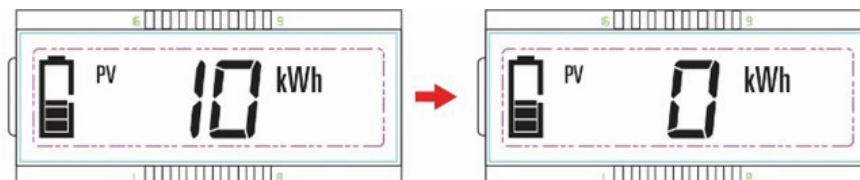

3) Battery type

- + Battery type
 - Sealed Gel Flooded User(1)
- + Set battery type by LCD(1)

Operation:

Step 1: Press the “SET” button and hold 5s under the battery voltage interface.

Step 2: Press the “MENU” button when the battery type interface is flashing.

Step 3: Press the “SET” button to confirm the battery type.

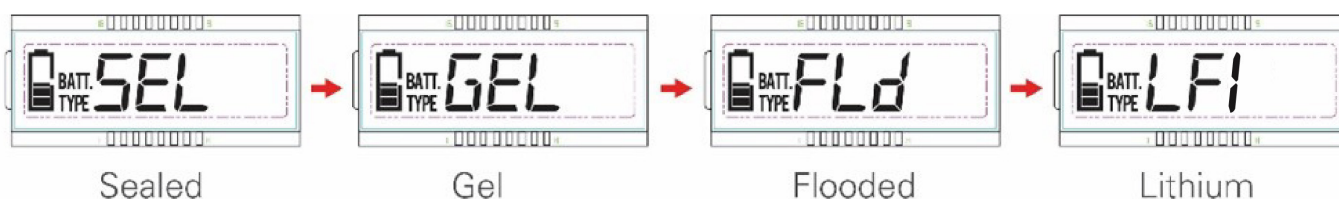

9. LED INDICATORS

- Red - Low Light
- Red/Green - Over current (Over 9A)

10. BATTERY CHARGING PROFILE CHART

ITEM	SEALED	GEL	FLOODED	LF1 (12V)	LF2 (24V)
Over Voltage Disconnect Voltage	16.0V	16.0V	16.0V	14.6V	29.2V
Charging Limit Voltage	15.0V	15.0V	15.0V	14.8V	28.8V
Over Voltage Reconnect Voltage	15.0V	15.0V	15.0V	14.8V	28.8V
Equalize Charging Voltage	14.6V	—	14.8V	—	—
Boost Charging Voltage	14.4V	14.2V	14.6V	14.8V	28.8V
Float Charging Voltage	13.8V	13.8V	13.8V	14.0V	28.0V
Boost Reconnect Charging Voltage	13.2V	13.2V	13.2V	13.2V	26.4V
Low Voltage Reconnect Voltage	12.6V	12.6V	12.6V	12.2V	24.4V
Under Voltage Warning Reconnect Voltage	12.2V	12.2V	12.2V	12.4V	28.8V
Under Voltage Warning Voltage	12.0V	12.0V	12.0V	12.0V	24.0V
Low Voltage Disconnect Voltage	11.1V	11.1V	11.1V	11.0V	22.0
Discharging Limit Voltage	10.6V	10.6V	10.6V	10.5V	21.0V
Equalize Duration	120min.	—	120min.	—	—
Boost Duration	120min.	120min.	120min.	120min.	120min.

1. When the battery type is sealed, gel, flooded, the adjusting range of equalizing duration is 0 to 180min and boost duration is 10 to 180min.
2. When setting a custom "User" battery type, (for example: a LiFePO4) use these rules when setting voltage parameters.

Note LFP1 is used for 12V Lithium batteries. LFP2 is used for 24V lithium batteries and should not be used for the DuraLITE kit.

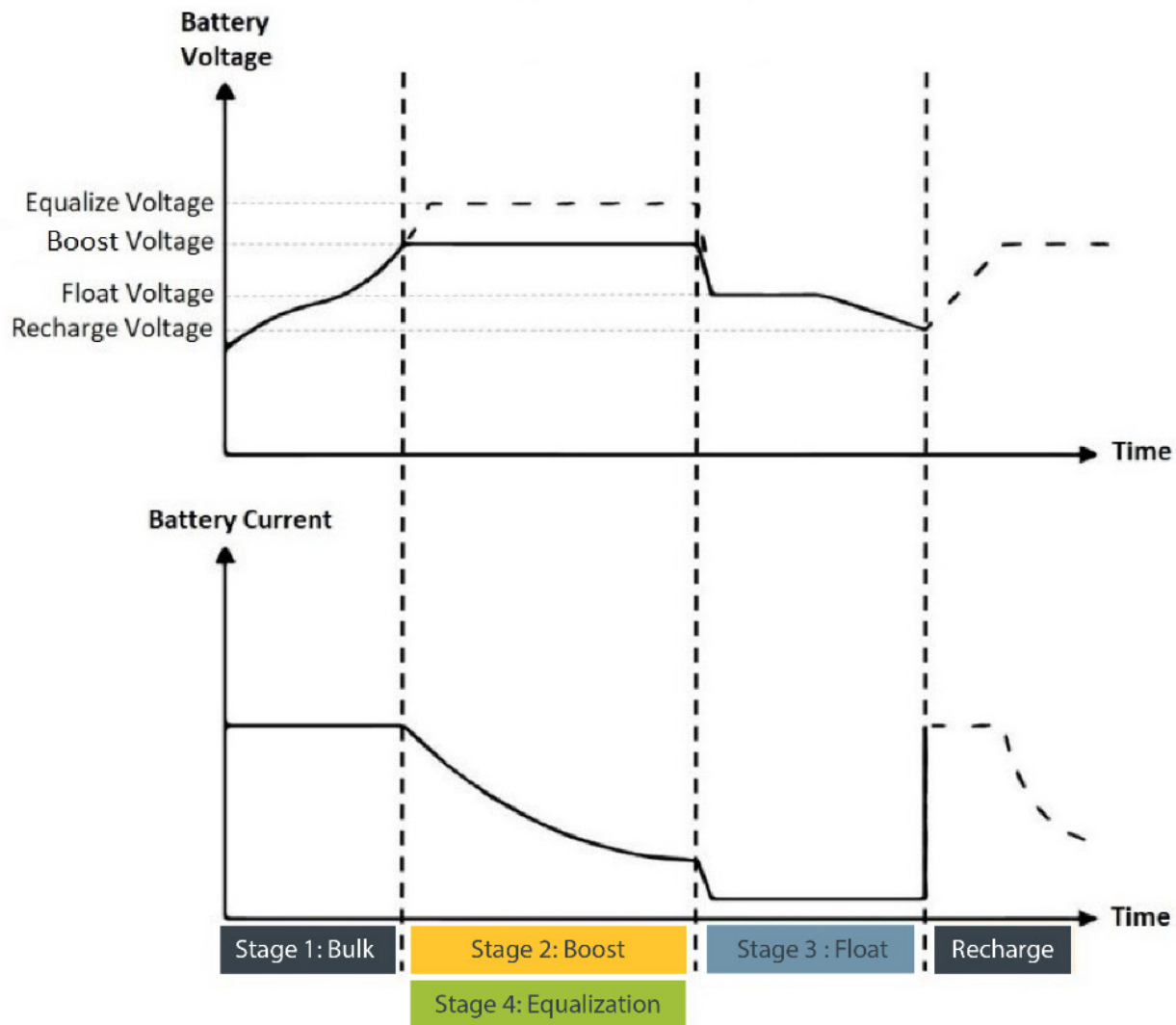

- Over Voltage Disconnect Voltage > Charging Limit Voltage \geq Equalize Charging Voltage \geq Boost Charging Voltage \geq Float Charging Voltage > Boost Reconnect Charging Voltage.
- Over Voltage Disconnect Voltage > Over Voltage Reconnect Voltage
- Low Voltage Reconnect Voltage > Low Voltage Disconnect Voltage \geq Discharging Limit Voltage.
- Under Voltage Warning Reconnect Voltage > Under Voltage Warning Voltage \geq Discharging Limit Voltage.
- Boost Reconnect Charging voltage > Low Voltage Disconnect Voltage.

11. ERRORS AND TROUBLESHOOTING

No Power to LCD Screen

Solution 1

Check the connection between the DuraLITE Kit and the controller, and the controller and the battery. The controller requires a minimum voltage of 8v to run.

Solution 2

Your battery may be too far discharged to accommodate the controller. Keep the solar kit plugged in and placed in full sun for a few hours and try the controller again.



FLASHING

Solution



This is an Overvoltage Error. The battery voltage is too high. Disconnect the DuraLITE kit and plug in a power draw to lessen the voltage in the battery.



FLASHING

Solution

This is an Over Discharge Error. The battery voltage is too low. Connect the DuraLITE kit to charge the battery.

ICON	MOTION	ISSUE
	Solid	The system is normal but not charging
	Energy bars are Flashing	Charging
	Solid	Full
	Flashing	Battery Overvoltage
	Flashing	Battery Over Discharge

13. FREQUENTLY ASKED QUESTIONS

Before a problem is suspected with the system, read this section. There are numerous events that may appear as problems but are in fact perfectly normal. Please visit <https://gpelectric.com/support/> for the most up-to-date FAQs and troubleshooting videos.

It seems like my flooded batteries are losing water over time.

Flooded batteries may need to have distilled water added periodically to replace fluid loss during charging. Excessive water loss during a short period of time indicates the possibility of overcharging or aging batteries.

When charging, my flooded batteries are emitting gas.

During charging, hydrogen gas is generated within the battery. The gas bubbles stir the battery acid allowing it to receive a fuller state of charge.

Important: Ensure batteries are in a well-ventilated space.

My voltmeter shows a different reading than the SOLAR CONTROLLER display.

The meter value on the SOLAR CONTROLLER display is an approximate reading intended for indication purposes only. There is an approximate 0.1 VDC inherent error present that may be accentuated when compared with readings from another voltmeter.

There may be a slight difference between the battery voltage displayed on the SOLAR CONTROLLER display and the battery voltage measured at the battery terminals. When troubleshooting using a voltmeter, check both the battery voltage at the SOLAR CONTROLLER controller terminals and battery voltage at the battery terminals. If a difference of more than 0.5 VDC is noted, this indicates a large voltage drop possibly caused by loose connections, long wire runs, small wire gauge, faulty wiring, a faulty voltmeter or all the above. Consult the Suggested Minimum Wire Gauge chart in Section 6 for wiring suggestions and check all connections.

For advanced users:

The SOLAR CONTROLLER makes voltage measurement adjustments based on resistance it detects at the battery terminals. In addition to resistance in the wires, batteries also have an internal resistance due to chemical properties. The controller cannot distinguish between these two sources of resistance. It will compensate up to 250mV in the displayed value.

Why does the voltage fluctuate so much when charging with the LITHIUM setting?

Lithium batteries contain smaller battery cells. The voltages of these individual cells must be balanced during the charging process by the Battery Management System (BMS). Imbalances will cause fluctuations in the battery voltage measurement, but this will stabilize as the cells are charged and balanced.

Additionally, lithium batteries have higher resistance than lead acid batteries. This affects the charge controller's battery voltage measurements and its compensation for wire resistance.

Reduce wire inductance which may also cause voltage fluctuations. Keep battery wires close together, or gently twist positive and negative wires together.

14. TROUBLESHOOTING

How to Read this Section

Troubleshooting Problems is split into three sub-sections, grouped by symptoms involving key components. A multimeter or voltmeter may be required for some procedures listed.

It is imperative all electrical precautions stated in the Warning Section and outlined in the Installation Section are followed. Even if it appears the system is not functioning, it should be treated as a fully functioning system generating live power.

14.1 PROBLEMS WITH CONTROLLER DISPLAY

Display Reading: Blank

Time of Day: Daytime/Nighttime

Possible Causes:

Battery or fuse connection and/or solar panel connection (Daytime only) or battery or fuse connection (Nighttime only).

Remedy:

Check all connections from the controller to the battery including checking for correct wire polarity. Check that all connections are clean, tight, and secure. Ensure the battery voltage is above 8 volts.

Further Steps (if required):

Check the voltage at the controller battery terminals with a voltmeter and compare with a voltage reading at the battery terminals.

If there is no voltage reading at the controller battery terminals, the problem could be a fuse, or the wiring between the battery and the controller. If the battery voltage is lower than 8 volts the controller will not function.

For the solar panel, repeat steps 1 and 2 substituting all battery terminals with solar panel terminals.

Display Reading: 0

Time of Day: Daytime/Nighttime

Remedy:

Check all connections from the controller to the battery including checking for correct wire polarity. Check that all connections are clean, tight, and secure.

Display Reading: Full battery icon flashing

Time of Day: Daytime/Nighttime



Remedy:

Overvoltage error. Disconnect the solar controller from the battery and put a draw on the battery (turn lights or a fan on) to drain the battery.

Reconnect solar panel after a few minutes. Repeat as needed.

Display Reading: Empty battery icon flashing

Time of Day: Daytime/Nighttime



Remedy:

Undervoltage error. Battery is too low to register a voltage to the solar controller. Plug your RV/trailer in to shore power to recharge battery to above 8v.

14.2 PROBLEMS WITH VOLTAGE

Voltage Reading: Inaccurate

Time of Day: Daytime/Nighttime

Possible Cause:

Excessive voltage drop from batteries to controller due to loose connections, small wire gauge or both.

Remedy:

Check all connections from the controller to the battery including checking for correct wire polarity. Check that all connections are clean, tight, and secure. Shorten the distance from the controller to the battery or obtain larger gauge wire. It is also possible to double up the existing gauge wire (i.e. two wire runs) to simulate a larger gauge wire.

Further Steps (if required):

Check the voltage at the controller battery terminals with a voltmeter and compare with the voltage reading at the battery terminals.

If there is a voltage discrepancy of more than 0.5 VDC, there is an excessive voltage drop.

14.3 PROBLEMS WITH CURRENT

Current Reading: 0 A

Time of Day: Daytime, clear sunny skies

Possible Cause:

Current is being limited below 1 Amp as per normal operation or there is a poor connection between the solar panel and the controller.

Remedy:

Check all connections from the controller to the panel including checking for correct wire polarity. Check that all connections are clean, tight, and secure. Continue with the solutions below for additional help on low current readings.

Further Steps (if required):

With the solar panel in sunlight, check the voltage at the controller solar panel terminals with a voltmeter.

If there is no reading at the controller solar panel terminals, the problem is somewhere in the wiring from the solar panel to the controller.

Current Reading: Less than expected

Time of Day: Daytime, clear sunny skies

Possible Causes:

1. Incorrect wiring connections.
2. Modules look dirty, overhead object is shading modules or it is an overcast day in which a shadow cannot be cast.
3. Dirty or shaded module or lack of sun.

Remedy:

1. Reconnect in correct configuration. Tighten all connections. Check wire to ensure no component has become loose or frayed.
- 2 Clean modules, clear obstruction or wait for conditions to clear.

Avoid any shading no matter how small. An object as small as a broomstick held across the solar module may cause the power output to be significantly reduced. Overcast days may also cut the power output of the module.

Further Steps (if required):

Disconnect one or both panel wires from the controller. Take a voltage reading between the positive and negative panel wire. A single 12 volt module should have an open circuit voltage between 17 and 23 VDC. If you have more than one solar module, you will need to conduct this test between the positive and negative terminals of each module junction box with either the positive or the negative wires disconnected from the terminal.

14.4 SOLAR PANEL LED INDICATORS

LED Showing: Solid Red

Time of Day: Daytime

Cause and Remedy

The panel is not receiving enough sunlight. Move the panel into a better position to capture more sunlight.

LED Showing: Flashing Red

Time of Day: Daytime

Cause and Remedy

There is a short circuit or an improper connection. Disconnect from the battery, unplug any USB devices and close the panel. Re-open the panel and try to reconnect all devices again.

15.1 CONNECTING EXPANSION KIT(S)

1. Connect the singular end of the branch connector (DuraLITE part #10) to the solar controller.
2. Place the solar controller (DuraLITE part #3) on the leg of the main solar kit using the Velcro fastener provided.
3. Connect the expansion cable (Expansion part #4) to the DC port (DuraLITE part #10) of the expansion panel.
4. Connect the other end of the expansion cable to the branch connector.
5. Repeat if connecting another expansion panel.

Note You do not need to utilize all 3 connections on the branch connector for the expansion kit to function. Connections are to be made red to red, black to black. You will hear a "click" when the connection has been made properly.

15.2 WIRING DIAGRAM

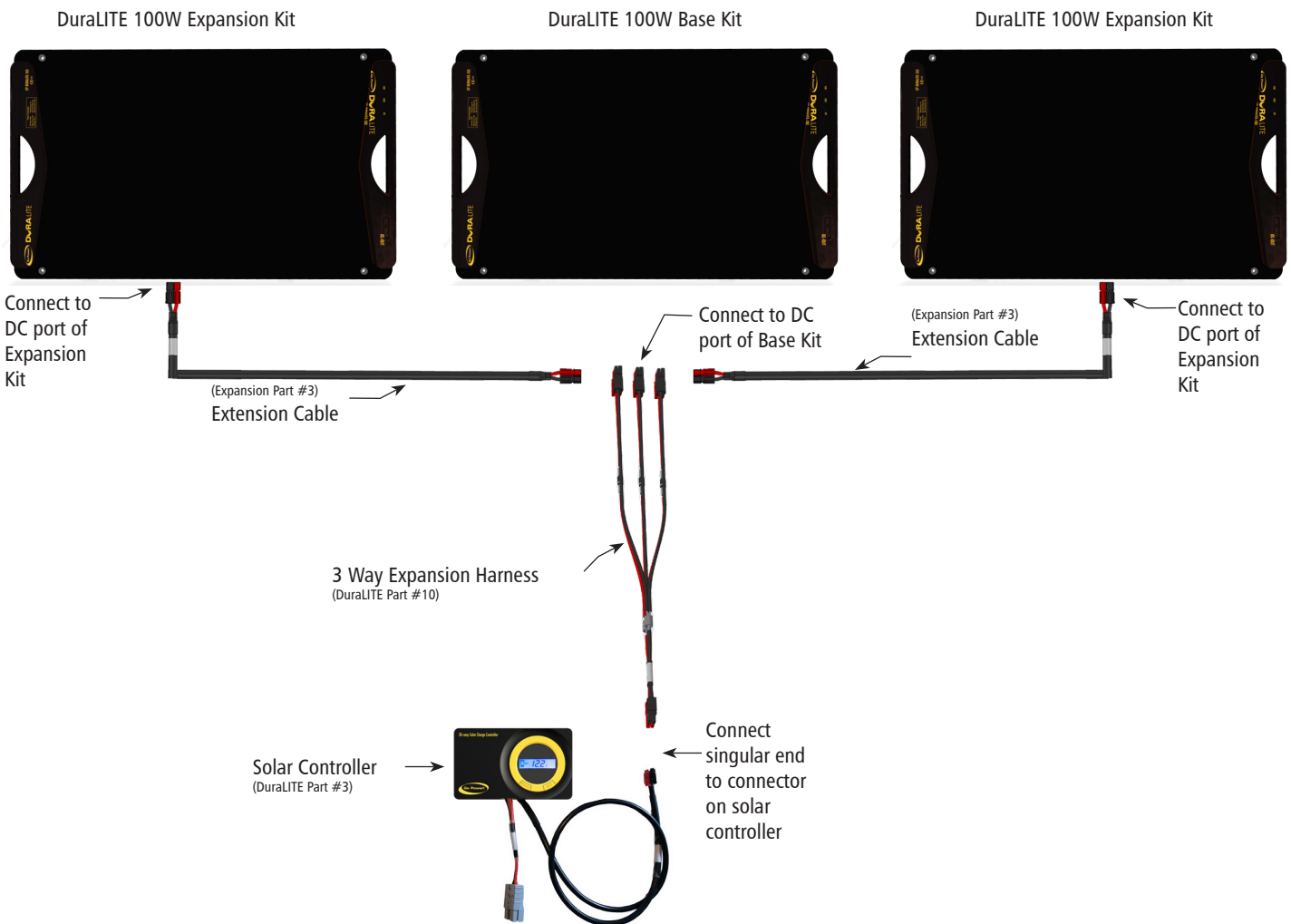

16. LIMITED WARRANTY



Go Power! warrants the solar panel of the DuraLITE Portable Solar Kit for 1 year, 1 year for the cable and components and 5 years for the solar controller. This warranty is valid against defects in materials and workmanship.

It is not valid against defects resulting from, but not limited to:

- Misuse and/or abuse, neglect, or accident
- Exceeding the unit's design limits
- Improper installation, including, but not limited to, improper environmental protection and improper hook-up
- Vandalism or theft
- Acts of God, including lightning, floods, earthquakes, fire, and high winds
- Damage in handling, including damage encountered during shipment or installation

Visit gpelectric.com for additional product warranty information.

Refer to the troubleshooting or frequently asked questions section in this manual and/or read our "frequently asked questions" on gpelectric.com to troubleshoot any problem. If trouble persists:

1. Call your Go Power! Technical Support team (1-866-247-6527).
2. Return defective product to place of purchase.

© 2022 Go Power!

Worldwide Technical Support and Product Information gpelectric.com

Go Power! | Dometic

201-710 Redbrick Street Victoria, BC, V8T 5J3

Tel: 1.866.247.6527

MAN_DURALITE-100-100E-PSK_RevA

